

PHILIPS

Fleta
Pebblo

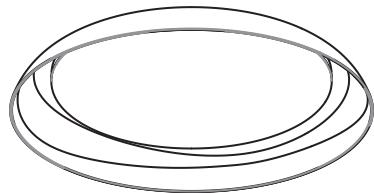
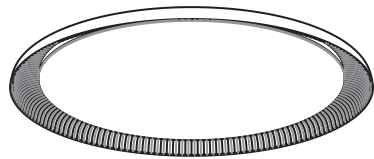
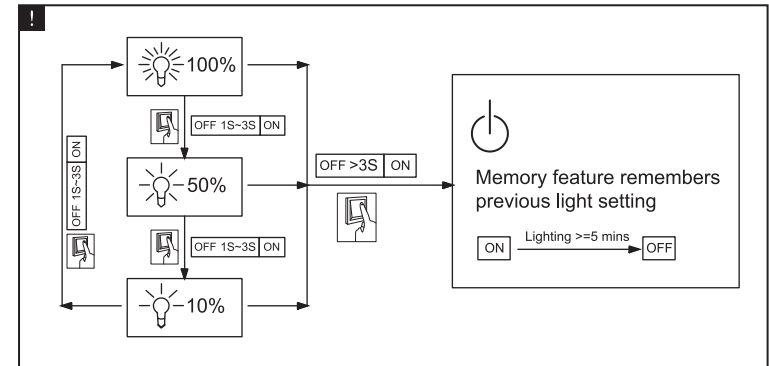
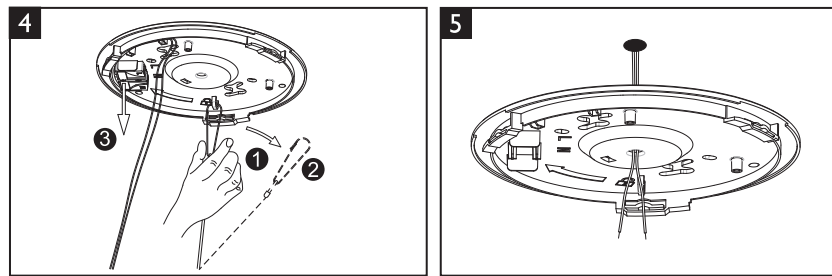
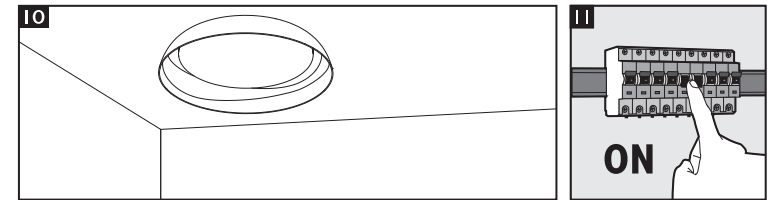
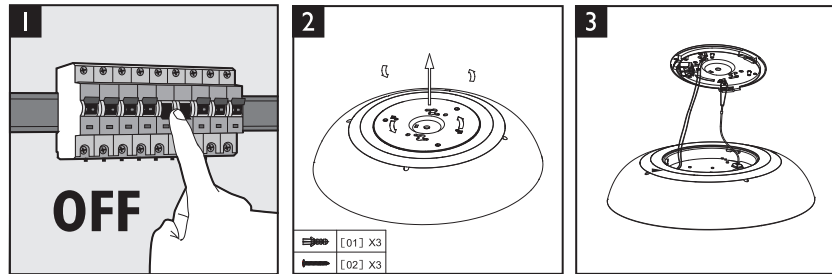
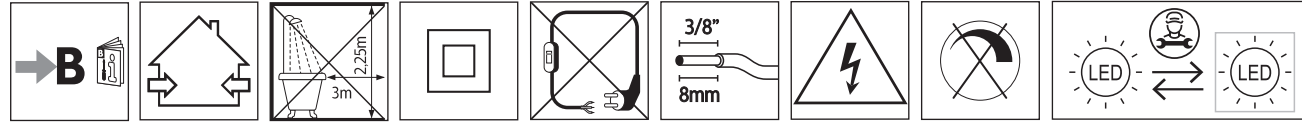

9290041166
9290041167
9290041168
9290041169

9290041162
9290041163
9290041164
9290041165

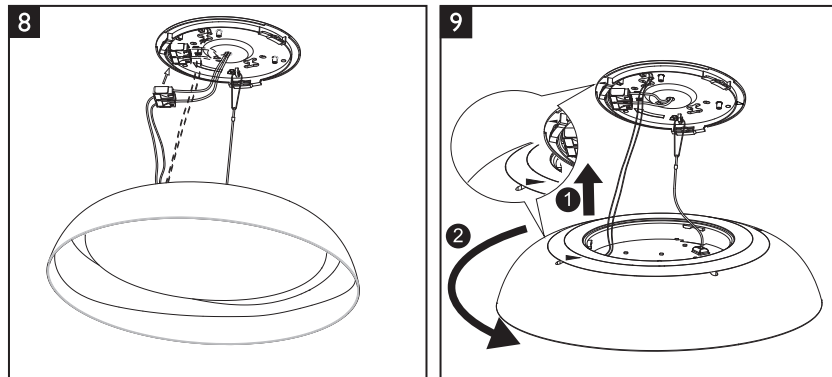
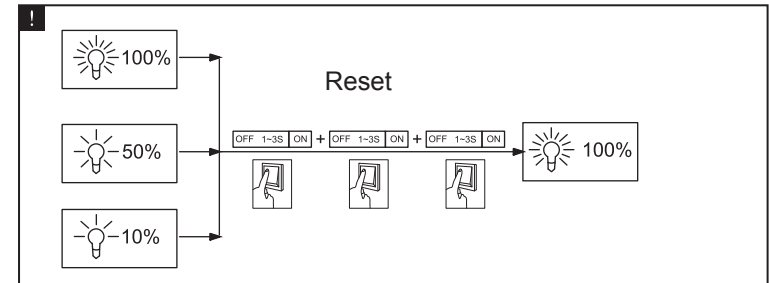
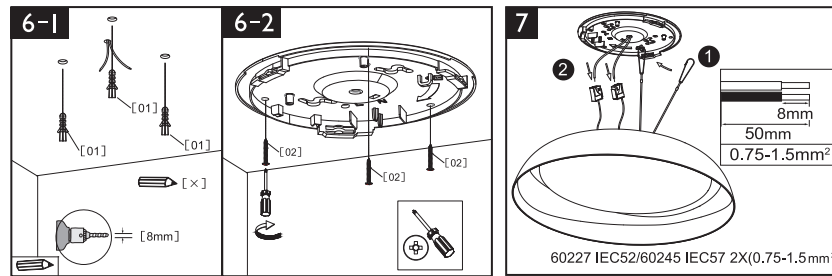

B 9290041168LS 9290041169LS 9290041166LS 9290041167LS
9290041164LS 9290041165LS 9290041162LS 9290041163LS

The light source contained in this luminaire shall only be replaced by the manufacturer or his service agent or a similar qualified person.

Philips and the Philips Shield Emblem are registered trademarks of Koninklijke Philips N.V. and are used under license
Signify
I.B.R.S. / C.C.R.I. Numéro 10461
5600VB Eindhoven, the Netherlands
www.philips.com/lighting



© 2024 Signify Holding
©ignify

Signify Commercial UK Limited
Unit 3, Guildford Business Park,
Guildford, Surrey, GU2 8XG, UK

3241 661 43281