



# QUICK START GUIDE

## Water Sensor

KURZANLEITUNG  
GUIA DE INICIO RÁPIDO  
GUIDE DE DÉMARRAGE RAPIDE  
GUIDA RAPIDA  
GUIA DE INÍCIO RÁPIDO

دليل البدء السريع



Anker Innovations Limited. All rights reserved. eufy Security and eufy Security Logo are trademarks of Anker Innovations Limited, registered in the United States and other countries. All other trademarks are the property of their respective owners.

**PAP 22**  
Raccolta Carta

51005003614 V1

English	01
Deutsch	10
Español	18
Français	26
Italiano	34
Português	42
العربية	50

## AT A GLANCE

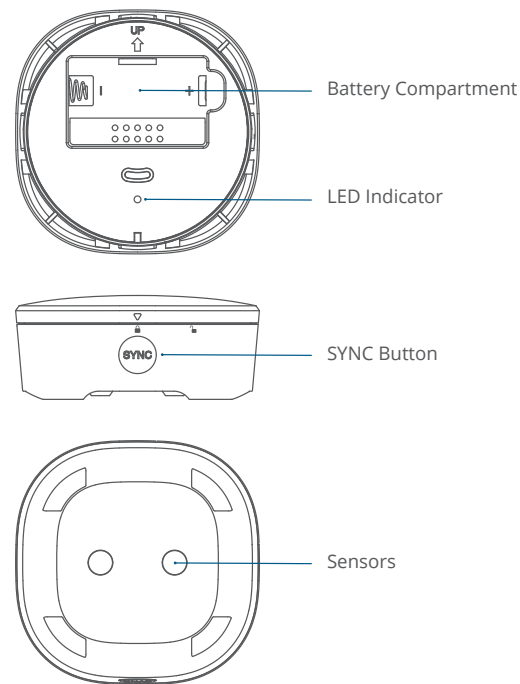

Model: T8920

# INSTALLING THE BATTERY

Remove the battery compartment cover of Water Sensor and insert the provided battery.

1. Twist the battery compartment cover anticlockwise.

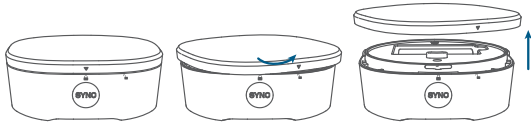

2. Insert the battery into the slot.

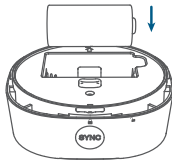

3. Replace the battery compartment cover and twist clockwise to lock it. Carefully line up the marks.

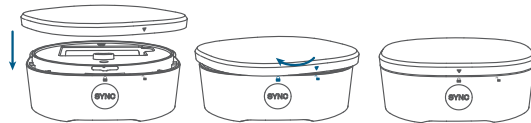

# ADDING WATER SENSOR TO YOUR SYSTEM

1. Download the eufy Security app from the App Store (iOS devices) or Google Play (Android devices).



2. Tap Add Device, choose Water Sensor, then select a HomeBase to link the sensor to.

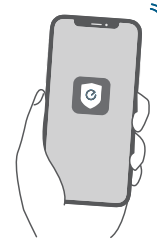

Make sure you've already setup your eufy Security HomeBase and updated the firmware to the latest version.

3. Press and hold the SYNC button for 3 seconds until the LED indicator blinks blue. This means Water Sensor is ready to pair.

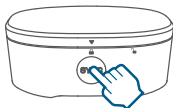

4. The LED indicator will turn solid blue for 5 seconds, which indicates the pairing has been successful. Then follow the in-app instructions to complete the setup.



## PLACING WATER SENSOR

Place Water Sensor on a flat surface.

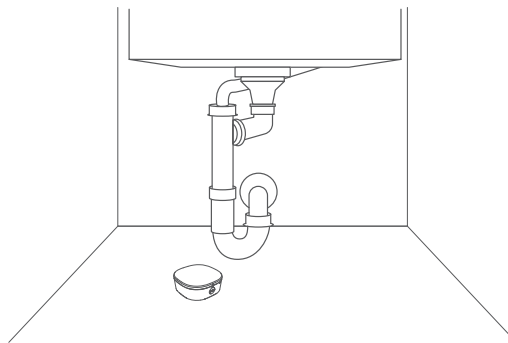

- Choose a location next to a possible source of flooding or freezing.
- Place Water Sensor in a location where it won't be moved unintentionally.

# SAFETY

The recommended temperature range for devices and accessories is -10°C to 40°C (14°F-104°F).

Unless specifically indicated that it is safe to do so in the user guide or instruction manual, do not use this device in an environment that exceeds the recommended low or high temperature.

Unless specifically indicated that it is safe to do so in the user guide or instruction manual, avoid exposing your device to direct sunshine or excessively wet environments.



**CAUTION!**  
THERE IS A RISK OF EXPLOSION IF AN INCORRECT BATTERY TYPE IS USED.  
DISPOSE OF USED BATTERIES ACCORDING TO THEIR INSTRUCTIONS.



**ATTENTION !**  
IL EXISTE UN RISQUE D'EXPLOSION EN CAS D'UTILISATION D'UN  
TYPE DE PILE INCORRECT.  
ÉLIMINEZ LES PILES USAGÉES CONFORMÉMENT AUX INSTRUCTIONS.

## Warning:

- Replacing a battery with an incorrect type may bypass safeguards and create danger;
- Disposal of a battery in a fire or other source of significant heat, or by crushing, or cutting, may result in an explosion as well as leakage of flammable liquids and gases;
- Leaving a battery in an extremely hot environment may result in an explosion as well as leakage of flammable liquids and gases;
- A battery subjected to extremely low air pressure may result in an explosion as well as leakage of flammable liquids and gases.

## Attention :

- Le remplacement d'une batterie par un type incorrect peut contourner les protections et créer un danger ;
- L'élimination d'une pile dans un feu ou une autre source de chaleur importante, ou par écrasement ou découpage, peut entraîner une explosion ainsi qu'une fuite de liquides et de gaz inflammables ;
- Le fait de laisser une batterie dans un environnement extrêmement chaud peut entraîner une explosion ainsi qu'une fuite de liquides et de gaz inflammables ;
- Une batterie soumise à une pression d'air extrêmement faible peut provoquer une explosion ainsi qu'une fuite de liquides et de gaz inflammables.

# NOTICE

## FCC Statement

This device complies with Part 15 of the FCC Rules. Operation is subject to the following two conditions: (1) this device may not cause harmful interference, and (2) this device must accept any interference received, including interference that may cause undesired operation.

Warning: Changes or modifications not expressly approved by the party responsible for compliance could void the user's authority to operate the equipment.

Note: This equipment has been tested and found to comply with the limits for a Class B digital device, pursuant to Part 15 of the FCC Rules. These limits are designed to provide reasonable protection against harmful interference in a residential installation.

This equipment generates uses and can radiate radio frequency energy and, if not installed and used in accordance with the instructions, may cause harmful interference to radio communications. However, there is no guarantee that interference will not occur in a particular installation. If this equipment does cause harmful interference to radio or television reception, which can be determined by turning the equipment off and on, the user is encouraged to try to correct the interference by one or more of the following measures: (1) Reorient or relocate the receiving antenna. (2) Increase the separation between the equipment and receiver. (3) Connect the equipment into an outlet on a circuit different from that to which the receiver is connected. (4) Consult the dealer or an experienced radio/TV technician for help.

## FCC Radio Frequency Exposure Statement

The device has been evaluated to meet general RF exposure requirements. The device can be used in fixed/mobile exposure condition. The min separation distance is 20cm.

Notice: Shielded cables

All connections to other computing devices must be made using shielded cables to maintain compliance with FCC regulations.

The following importer is the responsible party

Company Name: POWER MOBILE LIFE, LLC  
Address: 10900 NE 8th St, Ste 501, Bellevue WA 98004  
Telephone:1-800-988-7973

IC Statement:

This device complies with Industry Canada licence-exempt RSS standard(s). Operation is subject to the following two conditions:

- (1) this device may not cause interference, and
- (2) this device must accept any interference, including interference that may cause undesired operation of the device.

Le présent appareil est conforme aux CNR d'Industrie Canada applicables aux appareils radio exempts de licence. L'exploitation est autorisée aux deux conditions suivantes:

- (1) l'appareil ne doit pas produire de brouillage, et
- (2) l'utilisateur de l'appareil doit accepter tout brouillage radioélectrique subi, même si le brouillage est susceptible d'en compromettre le fonctionnement."

This Class B digital apparatus complies with Canadian ICES-003.

Cet appareil numérique de la classe B est conforme à la norme NMB-003 du Canada.

IC RF Statement:

When using the product, maintain a distance of 20cm from the body to ensure compliance with RF exposure requirements.

Lors de l'utilisation du produit, maintenez une distance de 20 cm du corps afin de vous conformer aux exigences en matière d'exposition RF.

 This product complies with the radio interference requirements of the European Community.

Declaration of Conformity

Hereby, Anker Innovations Limited declares that this device is in compliance with the essential requirements and other relevant provisions of Directive 2014/53/EU. For the declaration of conformity, visit the Web site: <https://uk.eufylife.com> .

 This product complies with the radio interference requirements of the United Kingdom

Declaration of Conformity

Hereby, Anker Innovations Limited declares that this device is in compliance with Radio Equipment Regulations 2017(SI 2017/1206). The full text of the UK declaration of conformity is available at the following internet address: <https://uk.eufylife.com> .

RF exposure information:

The Maximum Permissible Exposure (MPE) level has been calculated based on a distance of d=20 cm between the device and the human body. To maintain compliance with RF exposure requirement, use product that maintain a 20cm distance between the device and human body.

Frequency bands and power as below:

SUB-1G Frequency Range:866-866.8MHz ; Sub-1G Max Output Power: 9.837dBm

The following importer is the responsible party (contract for EU matters): Anker Innovations Deutschland GmbH | Georg-MuChe-Strasse 3, 80807 Munich, Germany The following importer is the responsible party (contract for UK matters): Anker Technology (UK) Ltd | GNR8, 49 Clarendon Road, Watford, Hertfordshire, WD17 1HP, United Kingdom



Your product is designed and manufactured with high quality materials and components, which can be recycled and reused.



This symbol means the product must not be discarded as household waste, and should be delivered to an appropriate collection facility for recycling. Proper disposal and recycling helps protect natural resources, human health and the environment. For more information on disposal and recycling of this product, contact your local municipality, disposal service, or the shop where you bought this product.

# AUF EINEN BLICK

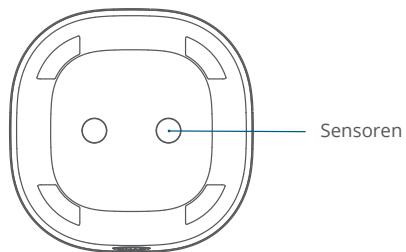
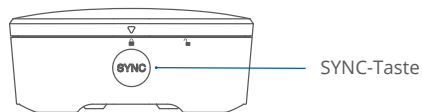
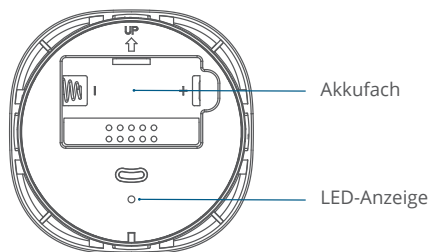

Modell: T8920  
10 DE

# BATTERIE EINLEGEN

Entfernen Sie die Batteriefachabdeckung des Wassersensors und legen Sie die mitgelieferte Batterie ein.

1. Drehen Sie die Batteriefachabdeckung gegen den Uhrzeigersinn.

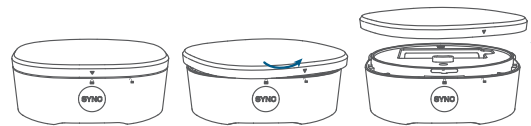

2. Setzen Sie die Batterie ein.

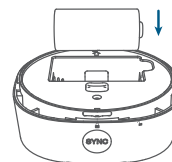

3. Bringen Sie die Batteriefachabdeckung wieder an und drehen Sie sie im Uhrzeigersinn, um sie zu verriegeln. Richten Sie die Markierungen sorgfältig aus.

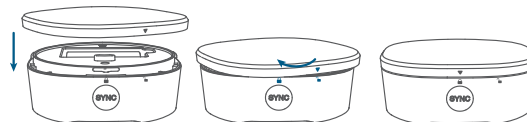

# WASSERSENSOR ZU IHREM SYSTEM HINZUFÜGEN

1. Laden Sie die eufy Security-App aus dem App Store (iOS-Geräte) oder von Google Play (Android-Geräte) herunter.



2. Tippen Sie auf Gerät hinzufügen, wählen Sie Wassersensor und dann eine HomeBase, mit der der Sensor verbunden werden soll.

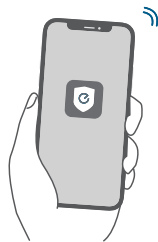

Stellen Sie sicher, dass Sie Ihre eufy Security HomeBase bereits eingerichtet und die Firmware auf die neueste Version aktualisiert haben.

3. Halten Sie die SYNC-Taste 3 Sekunden lang gedrückt, bis die LED-Anzeige blau blinkt. Dies bedeutet, dass der Wassersensor zum Koppeln bereit ist.

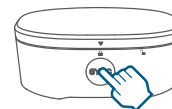

4. Die LED-Anzeige leuchtet 5 Sekunden lang durchgehend blau, was anzeigt, dass die Kopplung erfolgreich war. Folgen Sie dann den Anweisungen in der App, um die Einrichtung abzuschließen.





# WASSERSENSOR PLATZIEREN

Platzieren Sie den Wassersensor auf einer ebenen Fläche.

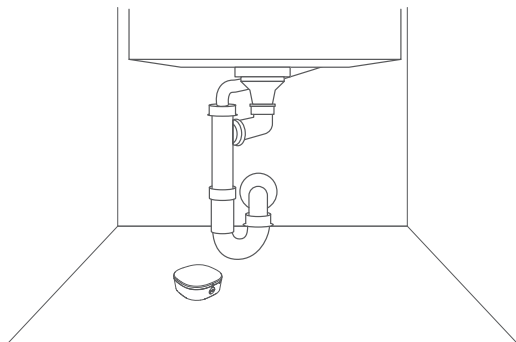

- Wählen Sie einen Ort neben einer möglichen Quelle für Überschwemmungen oder Gefrieren.
- Platzieren Sie den Wassersensor an einem Ort, an dem er nicht unbeabsichtigt bewegt werden kann.

# SICHERHEIT

Der empfohlene Temperaturbereich für Geräte und Zubehör beträgt -10 °C bis 40 °C.

Verwenden Sie das Gerät nicht in einer Umgebung, wo der empfohlene Temperaturbereich über- oder unterschritten wird, es sei denn, es wird in der Bedienungsanleitung ausdrücklich darauf hingewiesen, dass dies unbedenklich ist.

Sofern in der Bedienungsanleitung nicht ausdrücklich darauf hingewiesen wird, dass dies unbedenklich ist, sollten Sie Ihr Gerät nicht direkter Sonneneinstrahlung oder übermäßig feuchten Umgebungen aussetzen.



**VORSICHT!**  
ES BESTEHT EXPLOSIONSGEFAHR, WENN EIN FALSCHER  
BATTERIETYP VERWENDET WIRD.  
GEBRAUCHTE BATTERIEN ENTSPRECHEND DEN ANWEISUNGEN  
ENTSORGEN.

## Warnung:

- Wird eine Batterie durch einen falschen Typ ersetzt, können Sicherheitsvorkehrungen umgangen werden und Gefahren entstehen;
- Die Entsorgung einer Batterie in einem Feuer oder einer anderen Quelle großer Hitze oder durch Zerdrücken oder Zerschneiden kann zu einer Explosion sowie zum Auslaufen von brennbaren Flüssigkeiten und Gasen führen;
- Wenn Sie eine Batterie in einer extrem heißen Umgebung aufbewahren, kann es zu einer Explosion sowie zum Auslaufen von brennbaren Flüssigkeiten und Gasen kommen;
- Bei einer Batterie, die einem extrem niedrigen Luftdruck ausgesetzt ist, besteht Explosionsgefahr sowie die Gefahr des Austretens von brennbaren Flüssigkeiten und Gasen.

# HINWEIS

**CE** Dieses Produkt erfüllt die Anforderungen der Europäischen Gemeinschaft an Funkstörungen.

## Konformitätserklärung

Anker Innovations Limited erklärt hiermit, dass dieses Gerät die grundlegenden Anforderungen und anderen relevanten Bestimmungen der Richtlinie 2014/53/EG erfüllt. Die Konformitätserklärung finden Sie auf der Website: <https://uk.eufylife.com>.

**UK CA** Dieses Produkt erfüllt die Anforderungen an Funkstörungen des Vereinigten Königreichs

## Konformitätserklärung

Anker Innovations Limited erklärt hiermit, dass dieses Gerät die Funkanlagenrichtlinie 2017 (SI 2017/1206) erfüllt. Der vollständige Text der britischen Konformitätserklärung ist unter der folgenden Internetadresse verfügbar: <https://uk.eufylife.com>.

## Informationen zur HF-Exposition:

Die maximal zulässige Exposition (MPE) wurde basierend auf einem Abstand von  $d = 20$  cm zwischen dem Gerät und dem menschlichen Körper berechnet. Um die Anforderungen in Bezug auf die HF-Belastung zu erfüllen, muss zwischen dem Gerät und dem menschlichen Körper ein Abstand von mindestens 20 cm bestehen.

Die Frequenzbänder und Leistung sind wie folgt:

SUB-1G-Frequenzbereich: 866 ~ 866,8 MHz; Maximale Sub-1G-Ausgangsleistung: 9,837 dBm

Der folgende Importeur ist verantwortlich (Vertrag für EU-Belange):

Anker Innovations Deutschland GmbH | Georg-Muche-Straße 3, 80807 München, Deutschland

Der folgende Importeur ist verantwortlich (Vertrag für UK-Belange):

Anker Technology (UK) Ltd | GNR8, 49 Clarendon Road, Watford, Hertfordshire, WD17 1HP, United Kingdom



Ihr Produkt wird mit hochwertigen Materialien und Komponenten gefertigt, die recycelt und wiederverwendet werden können.



Dieses Symbol bedeutet, dass das Produkt nicht als Hausmüll entsorgt werden darf, sondern einer angemessenen Sammelstelle für das Recycling zugeführt werden muss. Durch das ordnungsgemäße Entsorgen und Recyceln tragen Sie zum Schutz natürlicher Ressourcen und zur Vermeidung von Umwelt- und Gesundheitsschäden bei. Weitere Informationen zu Entsorgung und Recycling des Produkts erhalten Sie von der Gemeinde vor Ort, dem Entsorgungsdienst oder dem Geschäft, in dem Sie dieses Produkt gekauft haben.

## VISTA GENERAL

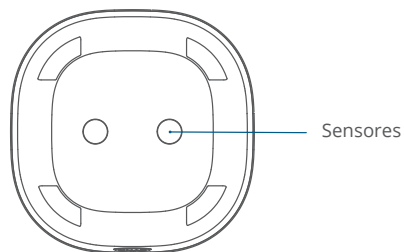
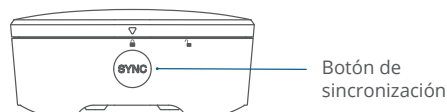
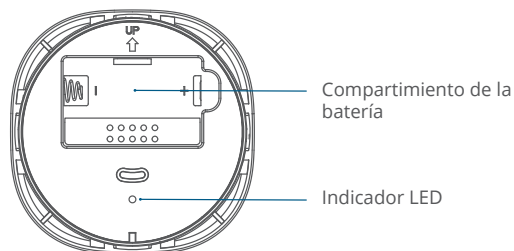

Modelo: T8920  
18 ES

## INSTALACIÓN DE LA PILA

Quite la tapa del compartimiento de la pila del sensor de agua y coloque la pila incluida.

1. Gire la tapa del compartimiento de la pila en el sentido contrario a las agujas del reloj.

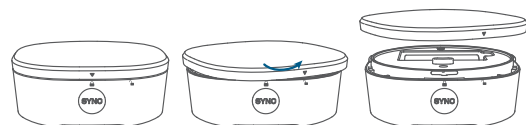

2. Coloque la pila en la ranura.

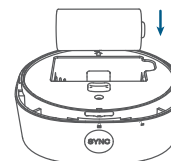

3. Vuelva a colocar la tapa del compartimiento de la pila y gírela en el sentido de las agujas del reloj para cerrarla bien. Alinee bien las marcas.



# AÑADIR UN SENSOR DE AGUA A SU SISTEMA

1. Descargue la aplicación eufy Security de la App Store (dispositivos iOS) o de Google Play (dispositivos Android).



2. Toque Añadir dispositivo, elija Sensor de agua y luego seleccione un HomeBase al que vincular el sensor.

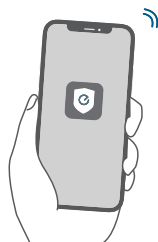

Compruebe que ya ha configurado su eufy Security HomeBase y ha actualizado el firmware a la última versión.

3. Mantenga pulsado el botón SYNC durante tres segundos hasta que el indicador parpadee en azul. Esto significa que el sensor de agua ya se puede emparejar.

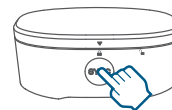

4. El indicador LED se volverá azul fijo durante 5 segundos, lo que indicará que el emparejamiento se ha realizado correctamente. Después, siga las instrucciones en la aplicación para completar la configuración.



# COLOCACIÓN DEL SENSOR DE AGUA

Coloque el sensor de agua sobre una superficie plana.

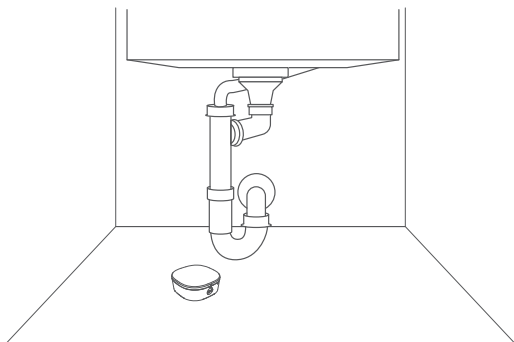

- Elija un lugar junto a una zona donde pueda producirse una posible inundación o congelamiento.
- Coloque el sensor de agua en un sitio donde no se mueva por accidente.

# SEGURIDAD

El rango de temperatura recomendada para dispositivos y accesorios es de -10 °C a 40 °C (14 °F- 104 °F).

No use este dispositivo en un ambiente que supere la temperatura baja o alta recomendada, a menos que se indique específicamente que es seguro hacerlo en la guía del usuario o el manual de instrucciones.

Evite exponer el dispositivo a la luz solar directa o ambientes excesivamente húmedos, a menos que se indique específicamente que es seguro hacerlo en la guía del usuario o el manual de instrucciones.



**PRECAUCIÓN**  
EXISTE RIESGO DE EXPLOSIÓN SI SE UTILIZA UN TIPO DE PILA INCORRECTO.  
DESECHE LAS PILAS USADAS TAL Y COMO SE INDICA EN LAS INSTRUCCIONES.

## Advertencia:

- Si se cambia la pila por otra de tipo incorrecto, la seguridad se podría ver comprometida y dar lugar a situaciones peligrosas;
- Tirar una pila al fuego u otra fuente de calor considerable, así como aplastarla o cortarla, puede provocar una explosión o fugas de líquidos y gases inflamables;
- Dejar la pila en zonas con muy altas temperaturas puede causar una explosión o fugas de líquidos y gases inflamables;
- Si se somete una pila a una presión de aire extremadamente baja, esto podría provocar una explosión o fugas de líquidos y gases inflamables.

# AVISO

**CE** Este producto cumple con los requisitos de radiointerferencias de la Comunidad Europea.

## Declaración de conformidad

Por la presente, Anker Innovations Limited declara que este dispositivo cumple los requisitos esenciales y otras disposiciones pertinentes de la Directiva 2014/53/UE. Para consultar la declaración de conformidad, visite el sitio web: <https://uk.eufylife.com>.

**UK CA** Este producto cumple con la normativa sobre radiointerferencias del Reino Unido

## Declaración de conformidad

Por la presente, Anker Innovations Limited declara que este dispositivo cumple con lo estipulado en el Reglamento 2017 en materia de equipos radioeléctricos (SI 2017/1206). El texto completo de la declaración de conformidad del Reino Unido está disponible en la siguiente dirección de Internet: <https://uk.eufylife.com/>

## Información de exposición a RF:

El nivel máximo de exposición permisible (MEP) se ha calculado en función de una distancia de  $d = 20$  cm entre el dispositivo y el cuerpo humano. Para preservar el cumplimiento con el requisito de exposición a RF, utilice el producto manteniendo una distancia de 20 cm entre el dispositivo y el cuerpo humano.

Las bandas de frecuencia y de potencia son las siguientes:

Rango de frecuencia SUB-1G: 866 ~ 866,8 MHz; Potencia de salida máxima Sub-1G: 9,837 dBm

La siguiente empresa importadora es la parte responsable (contacto en la UE):

Anker Innovations Deutschland GmbH | Georg-Muche-Strasse 3, 80807 Múnich, Alemania

La siguiente empresa importadora es la parte responsable (contacto en Reino Unido):

Anker Technology (UK) Ltd | GNR8, 49 Clarendon Road, Watford, Hertfordshire, WD17 1HP, United Kingdom



Su producto ha sido diseñado y está fabricado con materiales y componentes de alta calidad, que se pueden reciclar y volver a utilizar.



Este símbolo indica que el producto no debe desecharse como residuo doméstico, sino que debe depositarse en unas instalaciones de recogida adecuadas para su reciclaje.

La eliminación y el reciclaje adecuados ayudan a proteger los recursos naturales, la salud humana y el medio ambiente. Para obtener más información acerca de la eliminación y el reciclaje de este producto, póngase en contacto con su ayuntamiento, el servicio de retirada de desechos o la tienda donde compró el producto.

# RÉCAPITULATIF

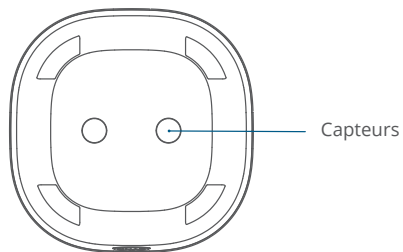
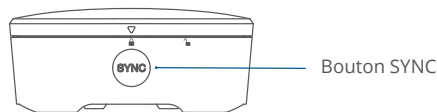
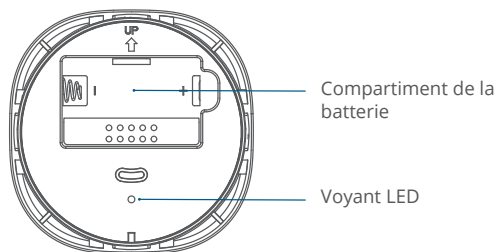

Modèle: T8920  
26 FR

# INSTALLATION DE LA PILE

Retirez le couvercle du compartiment de la pile du capteur d'eau et insérez la pile fournie.

1. Tournez le couvercle du compartiment de la pile dans le sens inverse des aiguilles d'une montre.

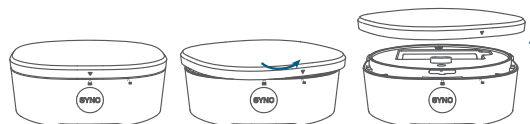

2. Insérez la pile dans la fente.

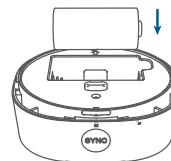

3. Remplacez le couvercle du compartiment de la pile et tournez dans le sens des aiguilles d'une montre pour le verrouiller. Alignez soigneusement les marques.



FR 27

# AJOUT D'UN CAPTEUR D'EAU À VOTRE SYSTÈME

1. Téléchargez l'application eufy Security depuis l'App Store (appareils iOS) ou Google Play (appareils Android).



2. Appuyez sur Ajouter un appareil, choisissez Capteur d'eau, puis sélectionnez un module HomeBase auquel lier le capteur.

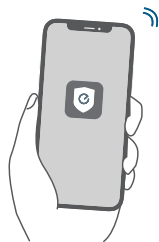

Assurez-vous que vous avez déjà configuré votre module eufy Security HomeBase et mis à jour le micrologiciel à l'aide de la dernière version.

3. Appuyez sur le bouton SYNC et maintenez-le enfoncé pendant 3 secondes jusqu'à ce que le voyant LED clignote en bleu. Cela signifie que le capteur d'eau est prêt à être couplé.

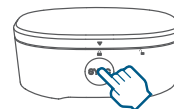

4. Le voyant LED deviendra bleu fixe pendant 5 secondes, ce qui indique que le couplage a réussi. Suivez ensuite les instructions de l'application pour terminer la configuration.





# PLACEMENT DU CAPTEUR D'EAU

Placez le capteur d'eau sur une surface plane.

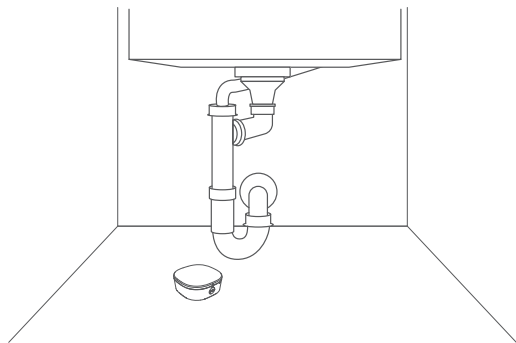

- Choisissez un emplacement à proximité d'une source possible d'inondation ou de gel.
- Placez le capteur d'eau dans un endroit où il ne risque pas d'être déplacé involontairement.

# SÉCURITÉ

La plage de température recommandée pour les appareils et accessoires est de -10 °C à 40 °C.

À moins qu'il ne soit spécifiquement indiqué dans le guide de l'utilisateur ou le manuel d'instructions que cela est sans danger, n'utilisez pas cet appareil dans un environnement qui dépasse les températures basses ou élevées recommandées.

Sauf indication contraire dans le guide de l'utilisateur ou le manuel d'instructions, évitez d'exposer votre appareil aux rayons directs du soleil ou à des environnements excessivement humides.



**ATTENTION !**  
IL EXISTE UN RISQUE D'EXPLOSION EN CAS D'UTILISATION D'UN TYPE DE PILE INCORRECT.  
ÉLIMINEZ LES PILES USAGÉES CONFORMÉMENT AUX INSTRUCTIONS.

## Attention :

- Le remplacement d'une batterie par un type incorrect peut contourner les protections et créer un danger ;
- L'élimination d'une pile dans un feu ou une autre source de chaleur importante, ou par écrasement ou découpage, peut entraîner une explosion ainsi qu'une fuite de liquides et de gaz inflammables ;
- Le fait de laisser une batterie dans un environnement extrêmement chaud peut entraîner une explosion ainsi qu'une fuite de liquides et de gaz inflammables ;
- Une batterie soumise à une pression d'air extrêmement faible peut provoquer une explosion ainsi qu'une fuite de liquides et de gaz inflammables.

# AVIS

**CE** Ce produit est conforme aux exigences en matière d'interférences radio de la Communauté européenne.

## Déclaration de conformité

Anker Innovations Limited déclare par le présent document que cet appareil est conforme aux exigences essentielles et aux autres dispositions pertinentes de la directive 2014/53/EU. Pour consulter la déclaration de conformité, consultez le site web suivant : <https://uk.eufylife.com>.

**UK  
CA** Ce produit est conforme aux exigences du Royaume-Uni en matière d'interférences radio

## Déclaration de conformité

Par la présente, Anker Innovations Limited déclare que ce dispositif est conforme au Règlement sur les équipements radio de 2017 (SI 2017/1206). Le texte intégral de la déclaration de conformité pour le Royaume-Uni est disponible à l'adresse suivante : <https://uk.eufylife.com>.

## Informations relatives à l'exposition aux radiofréquences :

La limite d'exposition maximale autorisée (norme MPE) a été calculée sur la base d'une distance de 20 centimètres entre l'appareil et le corps. Pour assurer la conformité aux exigences en matière d'exposition aux radiofréquences, utilisez le produit de manière à maintenir une distance de 20 cm entre l'appareil et le corps.

Bandes de fréquences et puissance comme ci-dessous :

Gamme de fréquences SUB-1G : 866 ~ 866,8 MHz ; puissance de sortie maximale Sub-1G : 9,837 dBm

L'importateur suivant est la partie responsable (contact pour les questions européennes) :

Anker Innovations Deutschland GmbH | Georg-Muche-Strasse 3, 80807 Munich, Allemagne

L'importateur suivant est la partie responsable (contact pour les questions relatives au Royaume-Uni) :

Anker Technology (UK) Ltd | GNR8, 49 Clarendon Road, Watford, Hertfordshire, WD17 1HP, United Kingdom



Votre produit a été conçu et fabriqué avec des matériaux et des composants de haute qualité. Ceux-ci peuvent être recyclés et réutilisés.



Ce symbole signifie que le produit ne doit pas être jeté avec les déchets ménagers, mais doit être transmis à un établissement de collecte adapté pour permettre son recyclage. Une élimination et un recyclage appropriés contribuent à protéger les ressources naturelles, la santé humaine et l'environnement. Pour en savoir plus sur l'élimination et le recyclage de ce produit, contactez votre municipalité, le service d'élimination des déchets ou le magasin où vous avez acheté ce produit.

# DESCRIZIONE DEL PRODOTTO

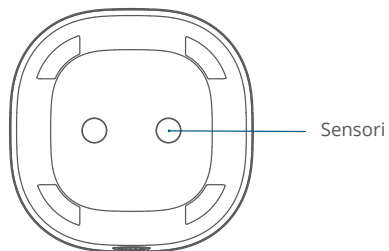
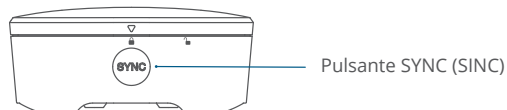
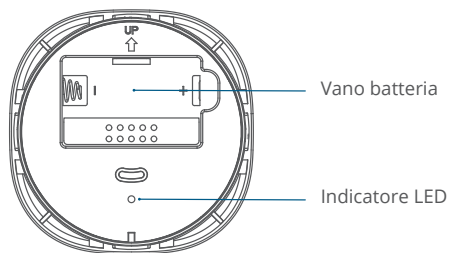

Modello: T8920  
34 IT

# INSTALLAZIONE DELLA BATTERIA

Rimuovere il coperchio del vano batteria del sensore Water Sensor e inserire la batteria in dotazione.

1. Ruotare il coperchio del vano batteria in senso antiorario.

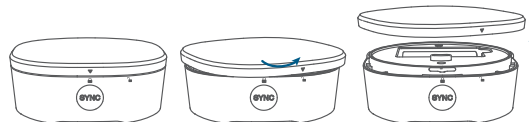

2. Inserire la batteria nell'alloggiamento.

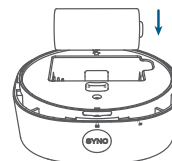

3. Riposizionare il coperchio del vano batteria e ruotarlo in senso orario per bloccarlo. Allineare i segni con attenzione.

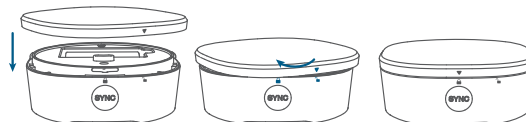

# AGGIUNTA DEL SENSORE WATER SENSOR AL SISTEMA

1. Scaricare l'app eufy Security dall'App Store (dispositivi iOS) o da Google Play (dispositivi Android).



2. Toccare Aggiungi dispositivo, scegliere Water Sensor, quindi selezionare una HomeBase a cui collegare il sensore.

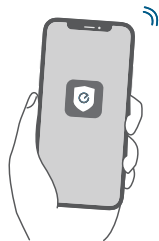

Accertarsi di avere già configurato eufy Security HomeBase e di avere aggiornato il firmware alla versione più recente.

3. Tenere premuto il pulsante SYNC per 3 secondi finché l'indicatore LED lampeggia in blu. Questo indica che il sensore Water Sensor è pronto per l'abbinamento.

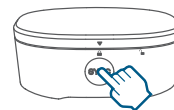

4. La luce dell'indicatore LED diventerà blu fissa per 5 secondi, a indicare che l'abbinamento è andato a buon fine. A questo punto, seguire le istruzioni dell'app per completare la configurazione.



# POSIZIONAMENTO DEL SENSORE WATER SENSOR

Posizionare il sensore Water Sensor su una superficie piana.

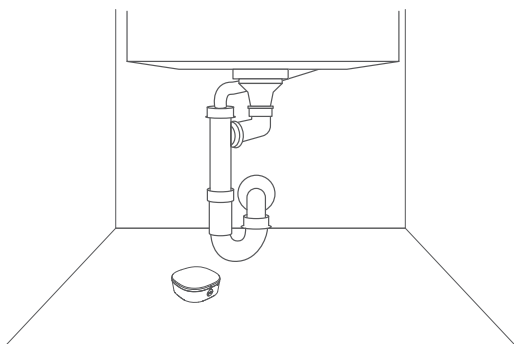

- Scegliere un luogo vicino a una possibile fonte di allagamento o congelamento.
- Posizionare il sensore Water Sensor in un luogo in cui sia al sicuro da spostamenti involontari.

# SICUREZZA

L'intervallo di temperatura consigliato per dispositivi e accessori è compreso tra -10°C e 40°C.

Non utilizzare questo dispositivo in un ambiente la cui temperatura supera il limite minimo o massimo consigliato, a meno che nel manuale dell'utente o nel manuale di istruzioni non sia espressamente indicato che l'uso a una temperatura diversa da quella indicata è sicuro.

Evitare di esporre il dispositivo alla luce diretta del sole o ad ambienti eccessivamente umidi, a meno che nel manuale dell'utente o nel manuale di istruzioni non sia espressamente indicato che l'uso in queste condizioni è sicuro.



**ATTENZIONE!**

L'USO DI UN TIPO DI BATTERIA ERRATO PUÒ COMPORTARE UN RISCHIO DI ESPLOSIONE.

SMALTIRE LE BATTERIE USATE SECONDO LE ISTRUZIONI.

## Avvertimento:

- La sostituzione di una batteria con una di tipo errato può aggirare le misure di sicurezza e creare pericolo;
- Lo smaltimento di una batteria nel fuoco o in un'altra fonte di calore importante oppure mediante schiacciamento o taglio può provocare un'esplosione e la fuoriuscita di liquidi e gas infiammabili;
- Lasciare una batteria in un ambiente con temperature estremamente elevate potrebbe provocare un'esplosione nonché la fuoriuscita di liquidi e gas infiammabili.
- Una batteria soggetta a pressione dell'aria estremamente bassa può provocare un'esplosione nonché la fuoriuscita di liquidi e gas infiammabili.

# AVVISO

**CE** Questo prodotto è conforme ai requisiti della Comunità europea relativi alle interferenze radio.

## Dichiarazione di conformità

Con il presente documento, Anker Innovations Limited dichiara che questo dispositivo è conforme ai requisiti fondamentali e alle altre disposizioni correlate previste dalla direttiva 2014/53/UE. Per la dichiarazione di conformità, visitare il sito Web: <https://uk.eufylife.com>.

**UK  
CA** Questo prodotto è conforme ai requisiti sulle interferenze radio del Regno Unito

## Dichiarazione di conformità

Con la presente, Anker Innovations Limited dichiara che questo dispositivo è conforme alle normative sulle apparecchiature radio 2017 (SI 2017/1206). Il testo completo della dichiarazione di conformità del Regno Unito è disponibile al seguente indirizzo Internet: <https://uk.eufylife.com>.

## Informazioni sull'esposizione a radiofrequenze:

Il livello di esposizione massima consentita (MPE) è stato calcolato sulla base di una distanza di 20 cm tra il dispositivo e il corpo umano. Per mantenere la conformità ai requisiti di esposizione alle radiofrequenze, utilizzare un prodotto che mantenga una distanza di 20 cm tra il dispositivo e il corpo umano.

Di seguito sono riportate le bande di frequenza e la potenza:

Gamma di frequenza SUB-1G: 866 ~ 866,8 MHz; Potenza massima in uscita SUB-1G: 9,837 dBm

Il seguente importatore è la parte responsabile (contratto esclusivamente per le questioni pertinenti all'UE):

Anker Innovations Deutschland GmbH | Georg-Muche-Strasse 3, 80807 Monaco, Germania

Il seguente importatore è la parte responsabile (contratto esclusivamente per le questioni pertinenti al Regno Unito):

Anker Technology (UK) Ltd, GNR8, 49 Clarendon Road, Watford, Hertfordshire, WD17 1HP, United Kingdom



Il prodotto è stato progettato e realizzato con materiali e componenti di alta qualità, che possono essere riciclati e riutilizzati.



Questo simbolo indica che il prodotto non deve essere smaltito tra i rifiuti domestici e deve essere consegnato presso un centro di raccolta per il riciclo. Un corretto smaltimento e riciclaggio aiuta a proteggere le risorse naturali, la salute umana e l'ambiente. Per ulteriori informazioni sullo smaltimento e il riciclo, contattare il comune locale, il servizio di smaltimento o il negozio in cui è stato acquistato il prodotto.

## VISTA GERAL

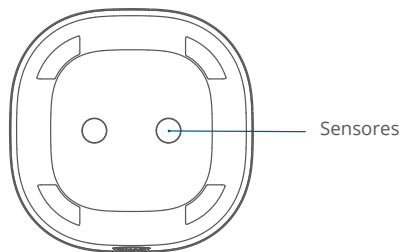
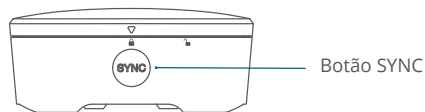
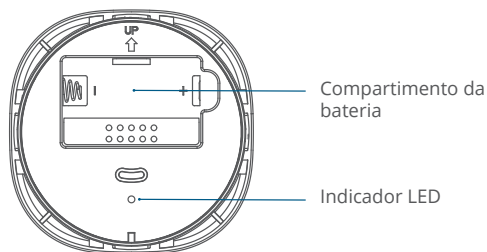

Modelo: T8920  
42 PT

## INSTALAR A BATERIA

Remova a tampa do compartimento da bateria do Sensor de água e insira a bateria fornecida.

1. Rode a tampa do compartimento da bateria no sentido oposto ao dos ponteiros do relógio.

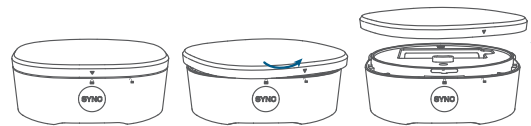

2. Insira a pilha na ranhura.

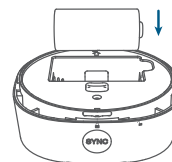

3. Volte a colocar a tampa do compartimento da bateria e rode no sentido dos ponteiros do relógio para a bloquear. Alinhe cuidadosamente as marcas.

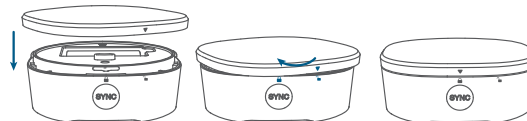

# ADICIONAR O SENSOR DE ÁGUA AO SISTEMA

1. Transfira a aplicação eufy Security a partir da App Store (dispositivos iOS) ou do Google Play (dispositivos Android).



2. Toque em Adicionar dispositivo, escolha Sensor de água e depois selecione uma HomeBase para associar o sensor.

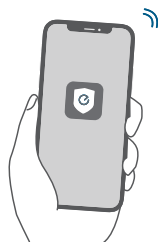

Certifique-se de que já configurou a eufy Security HomeBase e atualizou o firmware para a versão mais recente.

3. Prima sem soltar o botão SINCRONIZAR durante 3 segundos até que o indicador LED pisque a azul. Isto significa que o Sensor de água está pronto para ser emparelhado.

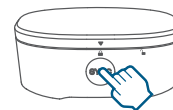

4. O indicador LED fica azul durante 5 seg, o que indica que o emparelhamento foi efetuado com êxito. Em seguida, siga as instruções apresentadas na aplicação para concluir a configuração.





# COLOCAR O SENSOR DE ÁGUA

Coloque o Sensor de água sobre uma superfície plana.

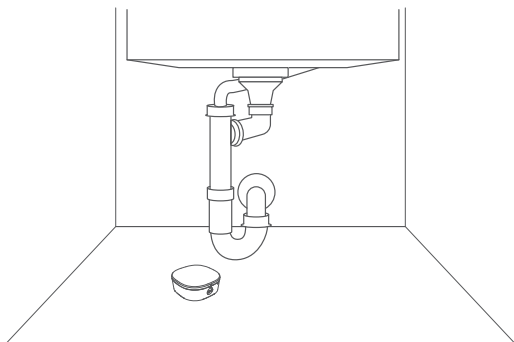

- Escolha um local próximo de uma possível fonte de inundação ou congelamento.
- Coloque o Sensor de água num local onde não seja movido involuntariamente.

# SEGURANÇA

O intervalo de temperatura recomendado para dispositivos e acessórios é de -10 °C a 40 °C.

Exceto quando o guia do utilizador ou o manual de instruções indica especificamente que é seguro proceder deste modo, não utilize este dispositivo num ambiente com uma temperatura inferior ou superior às temperaturas mínima e máxima recomendadas.

Exceto quando o guia do utilizador ou o manual de instruções indica especificamente que é seguro proceder deste modo, evite expor o dispositivo à luz solar direta ou a ambientes excessivamente húmidos.



**ATENÇÃO!**  
EXISTE UM RISCO DE EXPLOSÃO SE FOR UTILIZADA UMA BATERIA DE TIPO INCORRETO.  
ELIMINE AS BATERIAS USADAS DE ACORDO COM AS RESPATIVAS INSTRUÇÕES.

## Aviso:

- A substituição de uma bateria por uma de tipo incorreto pode anular as proteções e criar perigo;
- A eliminação de uma bateria por fogo ou outra fonte de calor intensa, ou por esmagamento ou corte, pode resultar numa explosão, bem como em fuga de líquidos e gases inflamáveis;
- Deixar uma bateria num ambiente com uma temperatura extremamente quente pode resultar numa explosão, bem como na fuga de líquidos e gases inflamáveis;
- A exposição de uma bateria a uma pressão de ar extremamente baixa pode resultar numa explosão, bem como na fuga de líquidos e gases inflamáveis.

# AVISO

**CE** Este produto cumpre as normas de interferências de rádio da Comunidade Europeia.

## Declaração de Conformidade

Por este meio, a Anker Innovations Limited declara que este dispositivo está em conformidade com os requisitos essenciais e outras disposições relevantes da Diretiva 2014/53/UE. Para consultar a declaração de conformidade, visite o site: <https://uk.euifylife.com>.

**UK  
CA** Este produto cumpre as normas de interferências de rádio do Reino Unido

## Declaração de Conformidade

Por este meio, a Anker Innovations Limited declara que este dispositivo está em conformidade com os Regulamentos de Equipamento de Rádio de 2017 (SI 2017/1206). O texto completo da declaração de conformidade do Reino Unido está disponível no seguinte endereço de Internet: <https://uk.euifylife.com>.

## Informações sobre exposição a RF:

O nível de Exposição Máxima Admissível (MPE - Maximum Permissible Exposure) foi calculado com base numa distância de  $d=20$  cm entre o dispositivo e o corpo humano. Para manter a conformidade com os requisitos de exposição a RF, utilize o produto mantendo uma distância de 20 cm entre o dispositivo e o corpo humano.

Bandas de frequência e potência possível indicadas abaixo:

Intervalo de frequências SUB-1G: 866-866,8 MHz; Potência de saída máx. Sub-1G: 9,837 dBm

O importador seguinte é a entidade responsável (contacte para questões no âmbito da UE):

Anker Innovations Deutschland GmbH | Georg-Muche-Strasse 3, 80807 Munique, Alemanha

O importador seguinte é a entidade responsável (contacte para questões no âmbito do Reino Unido)

Anker Technology (UK) Ltd | GNR8, 49 Clarendon Road, Watford, Hertfordshire, WD17 1HP, United Kingdom



O produto foi concebido e fabricado com materiais e componentes de alta qualidade, que podem ser reciclados e reutilizados.



Este símbolo significa que o produto não deve ser eliminado como lixo doméstico e deve ser entregue numa instalação de recolha apropriada para reciclagem. A eliminação e a reciclagem corretas ajudam a proteger os recursos naturais, a saúde humana e o ambiente. Para obter mais informações sobre a eliminação e a reciclagem deste produto, contacte o seu município, os serviços de eliminação ou o local de compra do produto.

## نظرة سريعة

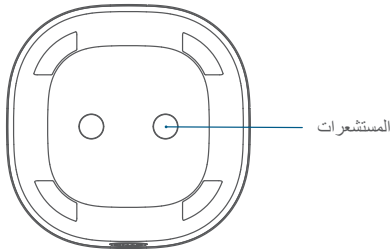
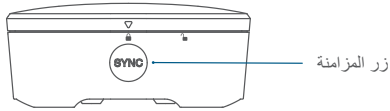
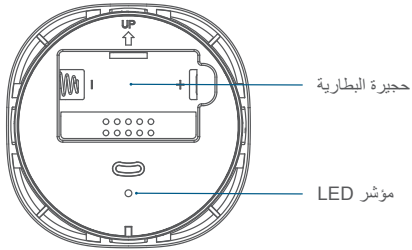

## إضافة مستشعر المياه إلى نظامك

1. نزل تطبيق eufy Security من App Store (أجهزة iOS) أو Google Play (أجهزة Android).



2. اضغط على "إضافة جهاز"، واختر "مستشعر المياه"، ثم حدد HomeBase لربط المستشعر به.

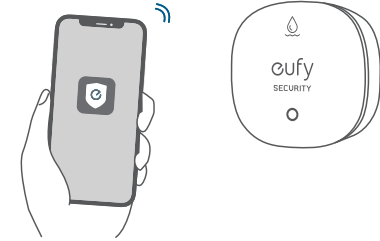

تأكد من أنك قمت بالفعل بإعداد eufy Security HomeBase وتحديث البرنامج الثابت إلى أحدث إصدار. 

## تركيب البطارية

افتح غطاء خُجيرة بطارية مستشعر المياه وأدخل البطارية المرفقة.  
1. قم بلف غطاء خُجيرة البطارية عكس اتجاه عقارب الساعة.

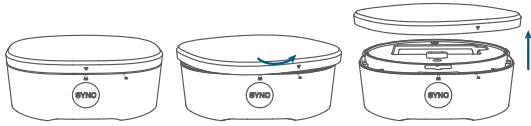

2. أدخل البطارية في الفتحة.

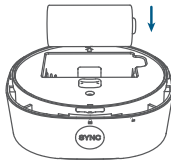

3. أعد تركيب غطاء خُجيرة البطارية وقم بلفه في اتجاه عقارب الساعة لقفله. قم بمحاذاة العلامات بعناية.

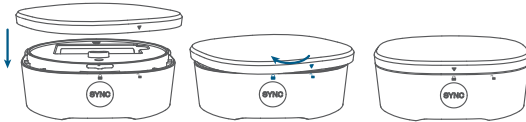

## اختيار موضع مستشعر المياه

ضع مستشعر المياه على سطح مستو.

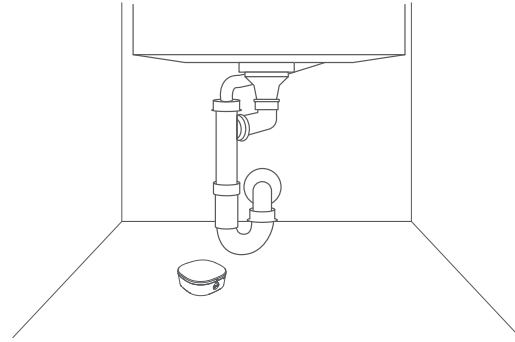

- اختر موقعًا بجوار مصدر محتمل للتعرض للفيضان أو التجمد.
- ضع مستشعر المياه في مكان لن يتعرض فيه للتحريك غير المقصود.

## إشعار



يتوافق هذا المنتج مع متطلبات التداخل اللاسلكي في الاتحاد الأوروبي.

بيان المطابقة

تعلن شركة Anker Innovations Limited بموجب هذا المستند أن هذا الجهاز يتوافق مع المتطلبات الأساسية والأحكام الأخرى ذات الصلة الواردة في التوجيه الأوروبي EU/2014/53. للاطلاع على إعلان المطابقة، تفضل بزيارة موقع الويب: <https://uk.eufylife.com>.



يتوافق هذا المنتج مع متطلبات التداخل اللاسلكي في المملكة المتحدة

بيان المطابقة

بموجب هذه الوثيقة، تعلن شركة Anker Innovations Limited أن هذا الجهاز متوافق مع لوائح المعدات اللاسلكية لعام 2017 (2017/1206 SI). النص الكامل لإعلان المطابقة في المملكة المتحدة متاح على عنوان الإنترنت التالي: <https://uk.eufylife.com>.

معلومات التعرض للترددات اللاسلكية:

تم حساب مستوى الحد الأقصى للتعرض المسموح به (MPE) بناءً على معادلة المسافة  $d = 20$  سم بين الجهاز وجسم الإنسان. وللحفاظ على الامتثال لمتطلبات التعرض للترددات اللاسلكية، استخدم المنتج الذي يحافظ على مسافة 20 سم بين الجهاز وجسم الإنسان.

نطاقات التردد والطاقة على النحو التالي:

نطاق تردد SUB-1G: 866 ~ 866.8 ميجا هرتز؛ الحد الأقصى لطاقة خرج SUB-1G: 9,837 ميلي واط

المستورد التالي هو الطرف المسؤول (عقد شؤون الاتحاد الأوروبي):

Anker Innovations Deutschland GmbH | Georg-Muche-Strasse 3, 80807 Munich، ألمانيا

المستورد التالي هو الطرف المسؤول (عقد شؤون المملكة المتحدة):

Anker Technology (UK) Ltd | GNR8, 49 Clarendon Road, Watford, Hertfordshire, WD17 1HP, United Kingdom

3. اضغط مع الاستمرار على زر SYNC (المزامنة) لمدة 3 ثوانٍ حتى يومض مؤشر LED باللون الأزرق. هذا يعني أن مستشعر المياه جاهز للإقران.

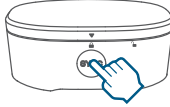

4. سيتحول مؤشر LED إلى اللون الأزرق الثابت لمدة 5 ثوانٍ، مما يشير إلى نجاح الاقتران. بعد ذلك، اتبع التعليمات داخل التطبيق لإكمال الإعداد.



تم تصميم هذا المنتج وتصنيعه بمواد ومكونات عالية الجودة يمكن إعادة تدويرها وإعادة استخدامها.



يشير هذا الرمز إلى أنه يجب عدم التخلص من النفايات المنزلية العادية، بل يجب تسليمه إلى المنشأة المناسبة لتجميع النفايات بغرض إعادة التدوير. ويساعد التخلص من المنتج وإعادة تدويره بشكل صحيح على حماية الموارد الطبيعية وصحة الإنسان والبيئة. ولمزيد من المعلومات حول التخلص من هذا المنتج وإعادة تدويره، اتصل بالبلدية المحلية أو خدمة التخلص من النفايات أو المتجر الذي اشتريت منه هذا المنتج.



## السلامة

نطاق درجة الحرارة الموصى به للأجهزة والملحقات هو 10- درجة مئوية إلى 40 درجة مئوية (14 فهرنهايت إلى 104 فهرنهايت).

لا تستخدم هذا الجهاز في بيئة تتجاوز درجة الحرارة المنخفضة أو المرتفعة الموصى بهما، ما لم يُذكر على وجه التحديد أنه من الأمان القيام بذلك في دليل المستخدم أو دليل التعليمات. تجنب تعريض جهازك لأشعة الشمس المباشرة أو البيئات شديدة الرطوبة، ما لم يُذكر على وجه التحديد أنه من الأمان القيام بذلك في دليل المستخدم أو دليل التعليمات.

تنبيه!



احذر من حدوث خطر الانفجار في حال استخدام نوع بطارية غير صحيح. تخلص من البطاريات المستخدمة وفقاً للتعليمات.

تحذير:

- قد يؤدي استبدال البطارية بنوع غير صحيح إلى التعدي على إجراءات الحماية والتسبب في حدوث مخاطر؛
- قد يؤدي التخلص من البطارية باستخدام أي من الطرق الآتية مثل حرقها أو تعريضها لأي مصدر آخر للحرارة الشديدة، أو عن طريق تكسيرها أو قطعها، إلى حدوث انفجار وكذلك تسرب السوائل والغازات القابلة للاشتعال؛
- قد يؤدي ترك البطارية في بيئة شديدة الحرارة إلى حدوث انفجار وكذلك تسرب السوائل والغازات القابلة للاشتعال؛
- قد يؤدي تعريض البطارية لضغط هواء منخفض للغاية إلى حدوث انفجار وتسرب السوائل والغازات القابلة للاشتعال.

# Customer Service

Kundenservice | Servicio de atención al cliente | Service  
client Servizio clienti | Serviço de Apoio ao Cliente | خدمة العملاء



12-month limited warranty | 12 Monate  
eingeschränkte Garantie | Garantia limitada de 12  
meses | Garantie limitée de 12 mois | Garanzia  
limitata di 12 mesi | 12 meses de garantia limitada |  
ضمان محدود لمدة 12 شهرًا



(US) +1 (800) 988-7973  
(UK) +44 (0) 1604 936200  
(DE) +49 (0) 69 9579 7960  
(中国) +86 400 0550 036  
(日本) +81 03 4455 7823  
(AU) +61 3 8331 4800  
(Egypt) +20 8000000826  
(UAE) +971 8000320817  
(Kuwait) +965 22069086  
(Saudi Arabia) +966 8008500030  
(Middle East & Africa) +971 42428633



support@eufylife.com

Anker Innovations Limited  
Room 1318-19, Hollywood Plaza, 610 Nathan Road, Mongkok,  
Kowloon, Hong Kong



@EufyOfficial



@EufyOfficial



@EufyOfficial