

What's in the Box

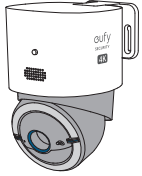

4G LTE Camera S330

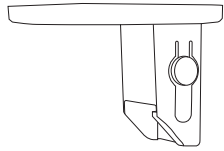

Camera Mounting Bracket

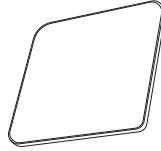

Solar Panel



Solar Panel Bracket



Pole Mounting Strap

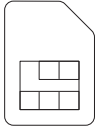

Nano SIM Card

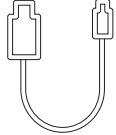

USB-C Charging Cable

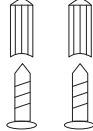

Screw Set



Quick Start Guide

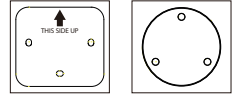

Positioning Stickers x2

At a Glance

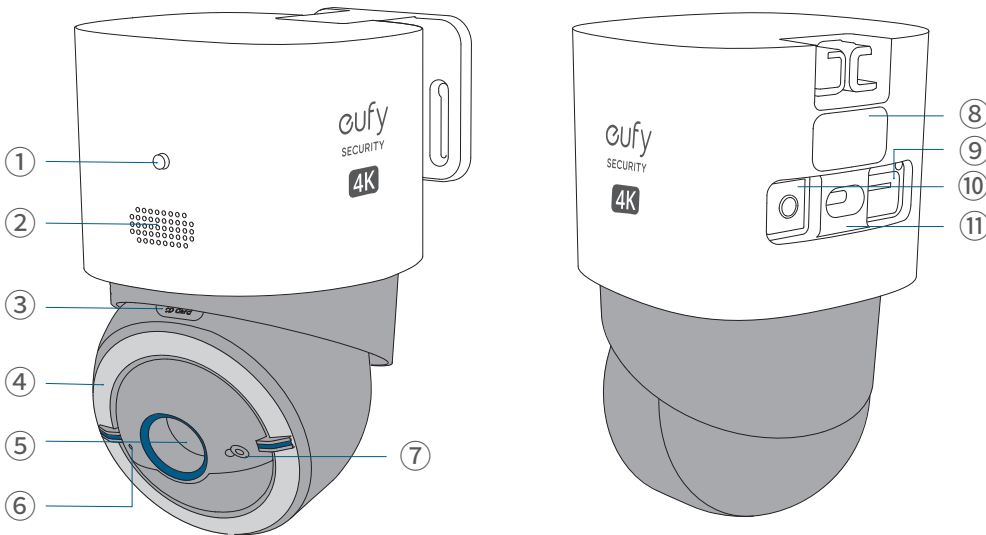

1	LED Indicator
2	Speaker
3	microSD Card Slot
4	Light
5	Lens
6	Microphone
7	Light Sensor
8	Antenna Port (Optional) You can install an antenna (not provided) to boost the signal strength as necessary.
9	SIM Card Slot
10	SYNC Button
11	USB-C Charging Port

Inserting SIM Card and microSD Card

1. Open the waterproof cover of the nano SIM slot on the back of the camera, then insert the provided nano SIM card.
 - Make sure the gold contacts side of the nano SIM card is facing up.

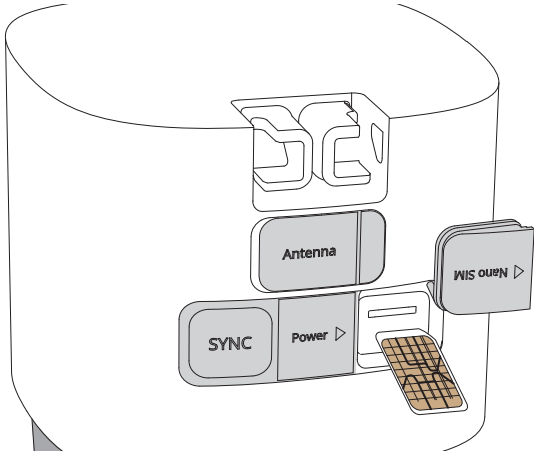

2. Rotate the camera and open the waterproof cover of the SD card slot, then insert a microSD card (not provided).
 - Make sure the chip side of the microSD card is facing up.

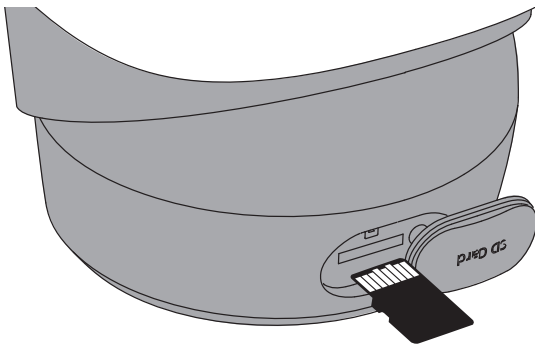

 Close tightly the waterproof cover after inserting the card.

Charging the Camera

Fully charge the camera prior to its initial use. Charging takes 3 to 5 hours to complete.

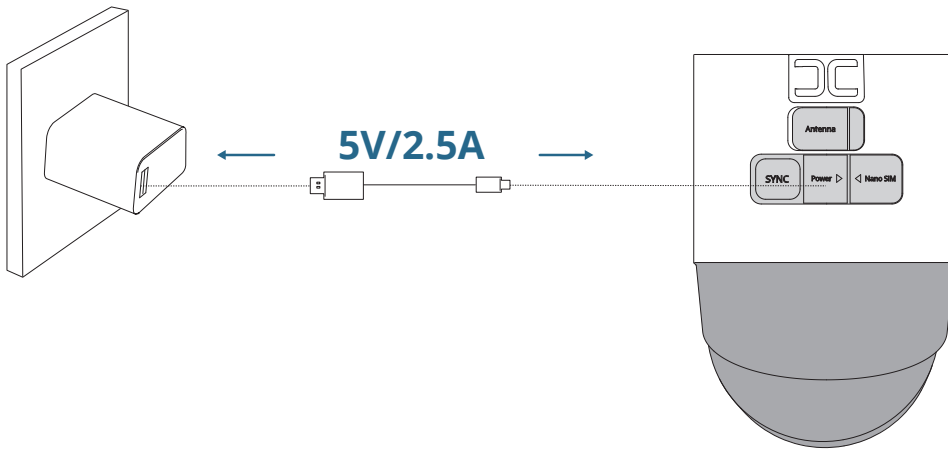

LED Indicator Status	Charging Status
Solid Blue	Charging
Light Off	Fully charged

Setting up the Camera

1. Download and install the eufy Security app, then sign in or create an account.



2. Follow the in-app instructions to add the camera to the device list.

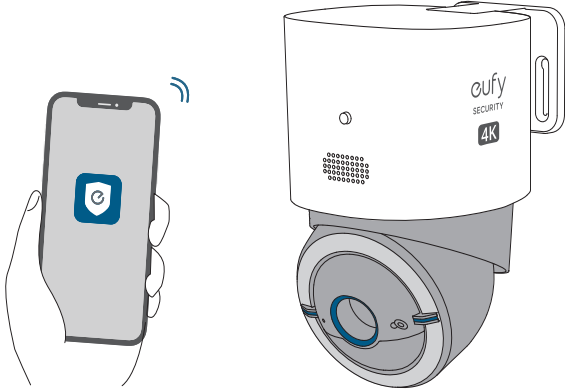

Mounting your Camera

Select a Location and a Height

Select a location where you can get the desired view. We recommend hanging the camera 8-10 ft (2.5-3 m) above the ground.

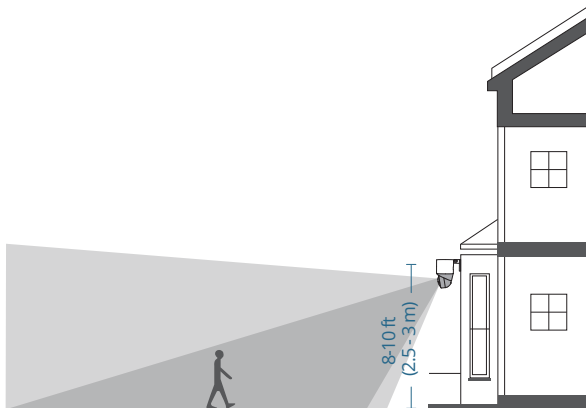

Up to 30 ft (9m)

To ensure that no detection is missed, do not install the camera directly facing the monitoring area. Instead, maintain an angle to avoid any potential blind spots.

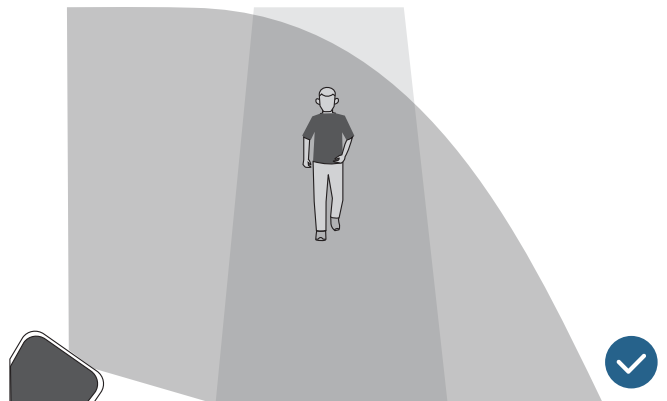
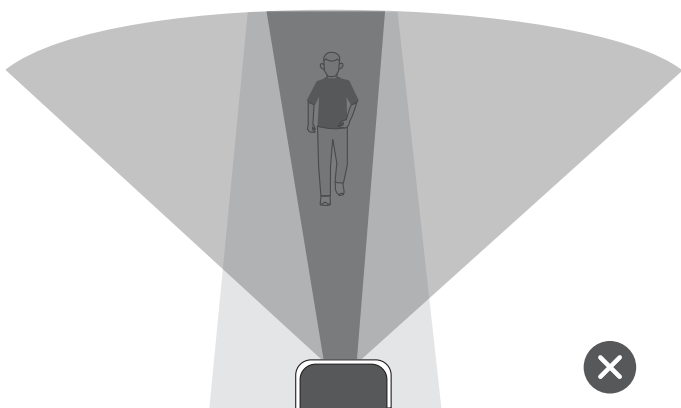

Select a Location for the Solar Panel

Select an optimal location for the solar panel that receives sufficient sunlight and is within a 10 ft (3 m) radius of the camera. Make sure the location has facilities or structures suitable for mounting the solar panel.

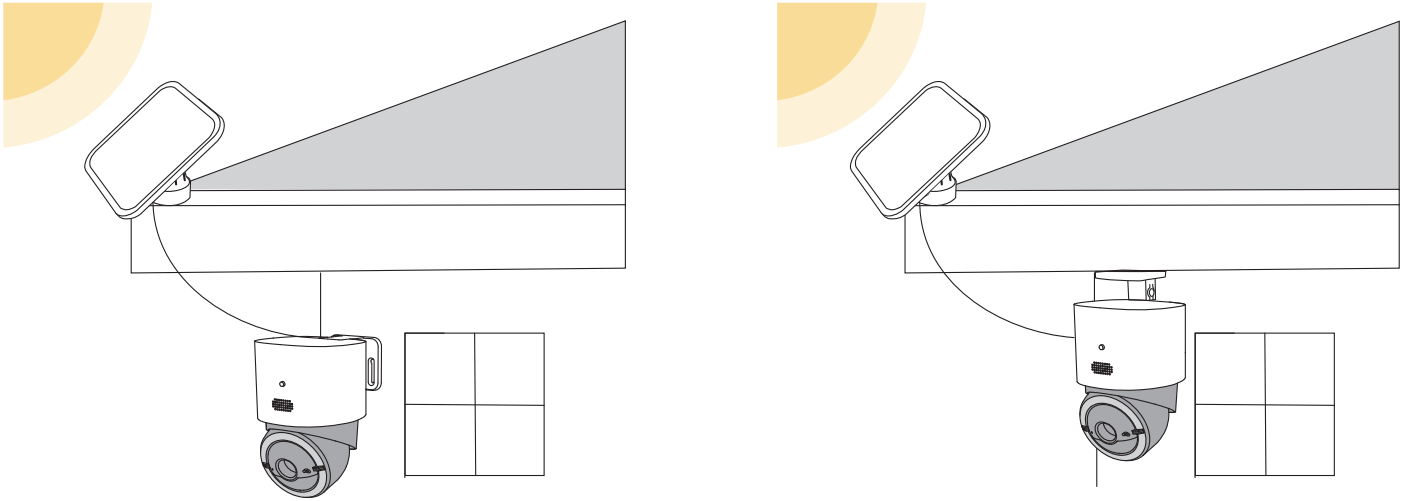

To absorb the most solar energy, choose the highly recommended orientation for installation based on your location.

Your Location	Orientation		
	Highly Recommended	Recommended	Not Recommended
Northern Hemisphere (US, UK, EU)	True South	Southwest or Southeast	North
Southern Hemisphere (Australia)	True North	Northwest or Northeast	South

Mount the Camera

1. Drill holes with a 15/64 inch (5.95 mm) drill bit with the provided positioning card, then insert the anchors into the holes.

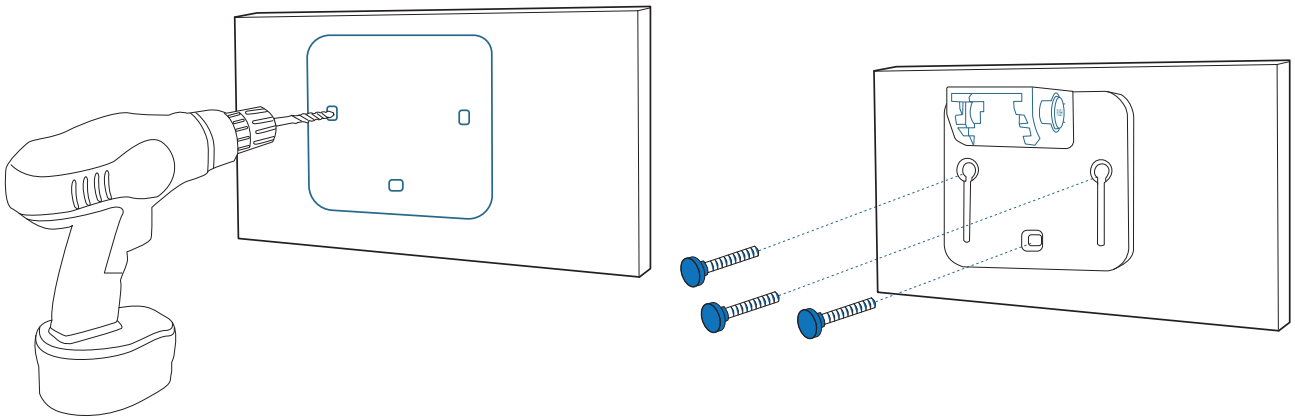

2. Firmly secure the camera onto the mounting bracket.

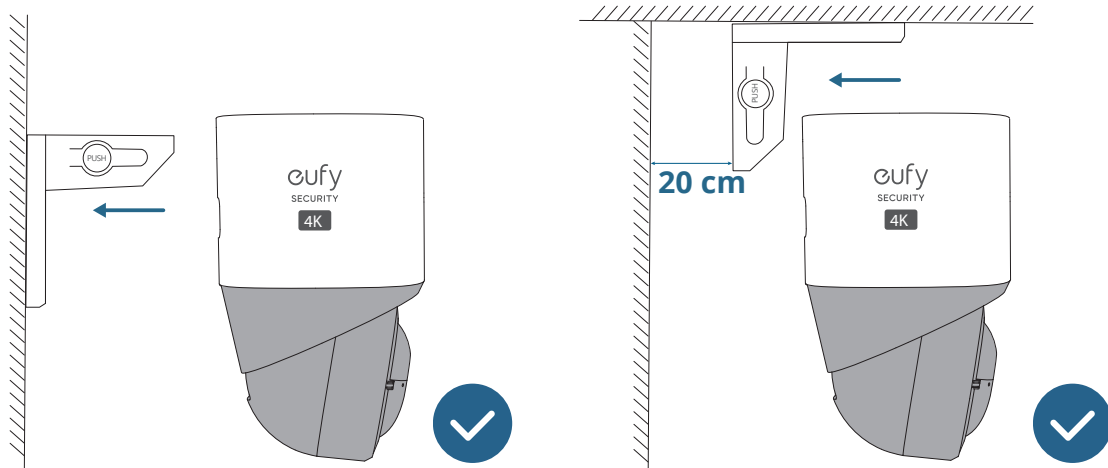

3. Connect the solar panel to the camera using the USB-C cable.

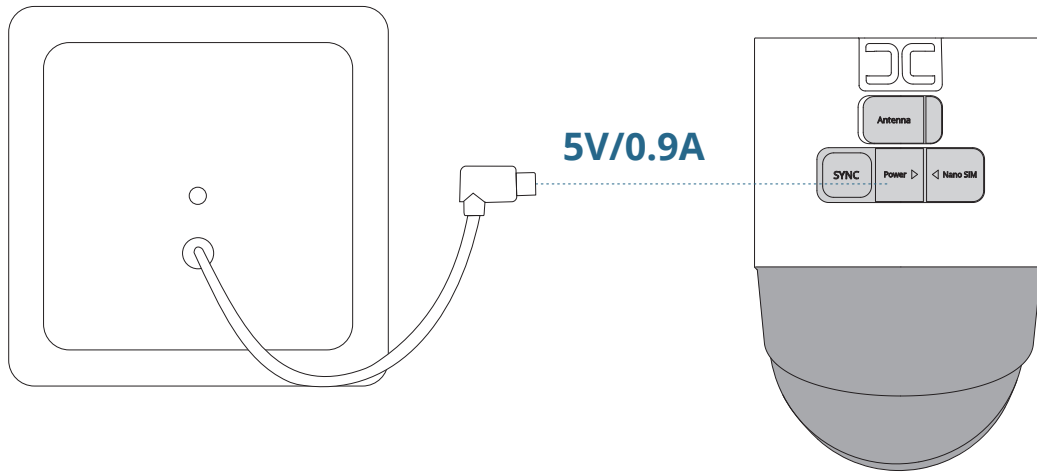

Bundling the Camera on a Post

You can also bundle the camera on a post using the pole mounting strap.

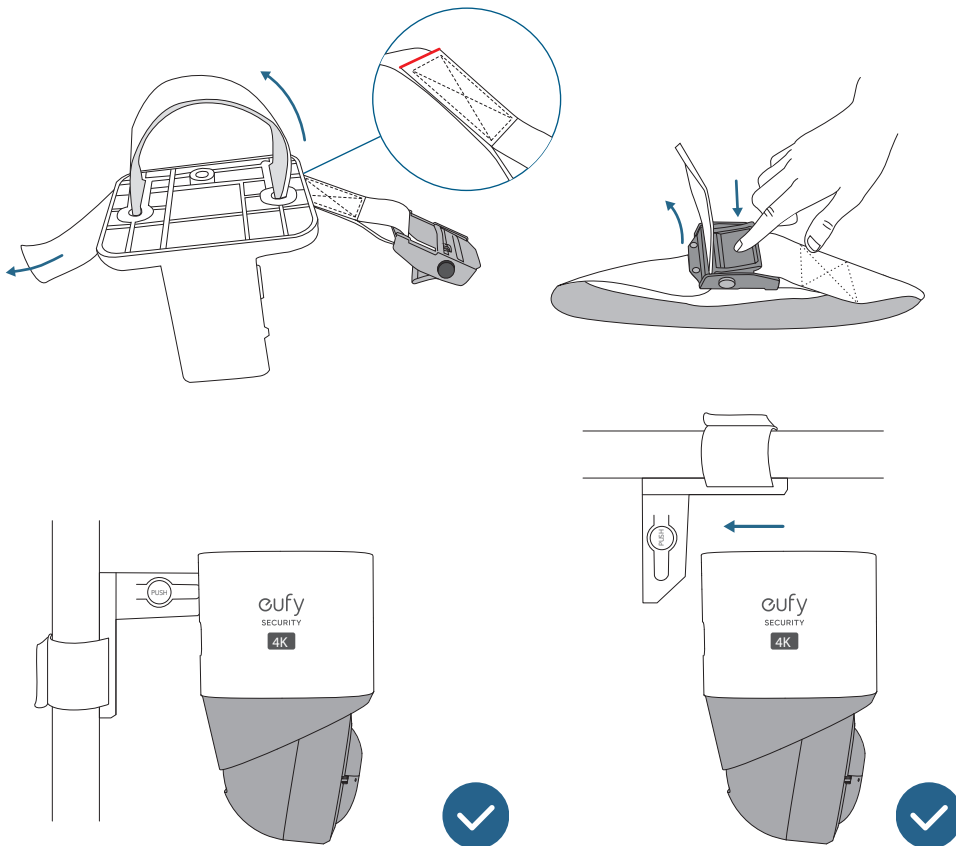

Install the Solar Panel

1. Secure the mounting bracket in the selected optimal location, then install the solar panel onto the mounting bracket by turning it.

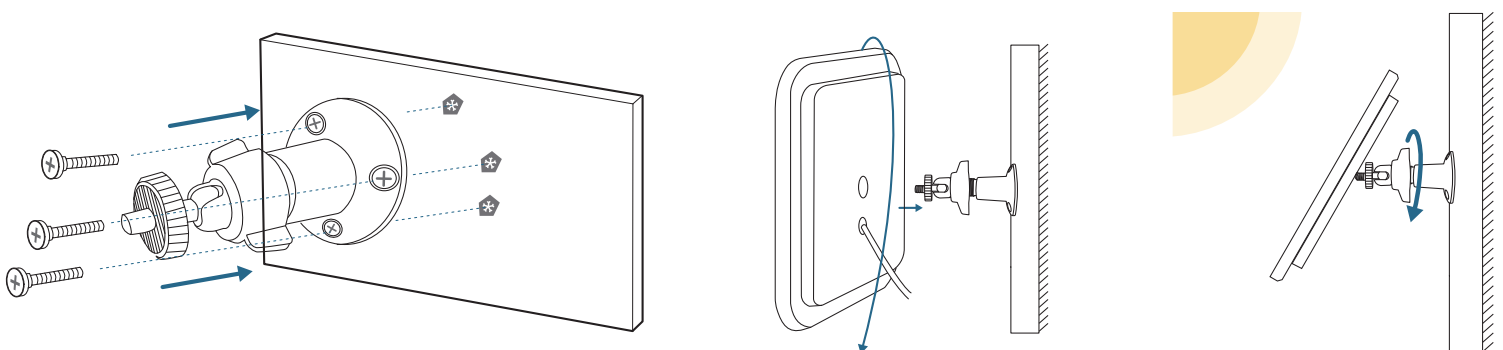

2. Remove the film before use.