

Contents

FOR VIDEO DOORBELL INSTALLATION

AT A GLANCE

HOW THE SYSTEM WORKS

CHARGING THE BATTERY PACK

SETTING UP THE SYSTEM

DETERMINING THE POWER OPTION

DOORBELL MOUNTING (Battery Powered)

DOORBELL MOUNTING (Wire Powered)

FOR VIDEO DOORBELL INSTALLATION

Click to view installation video: <https://youtu.be/pkkdyGZ1WX0>

What You Need

- Phillips-Head Screwdriver
- Power Drill (15/64" Drill Bit)

To work with the Minibase Chime:

Open the eufy Security App, go to **Doorbell Settings > Indoor Chime > Minibase Chime**, and follow the in-app instructions to complete the setup.

When the Minibase Chime is working with the doorbell:

1. The Minibase Chime only works as a chime.
2. Please insert the SD card into the doorbell to store videos.

What's in the Box



Video Doorbell C31
Model: T8223



Rechargeable Battery Pack

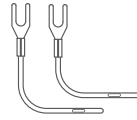

Extension Wires

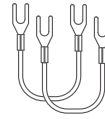

Jumpers for Existing
Chime



Mounting Bracket



15° Mounting Wedge
(Optional)



Screw Hole
Positioning Card

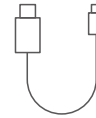

USB-C Charging Cable

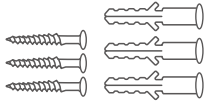

Screw Pack



Detaching Pin



Quick Start Guide

AT A GLANCE

Front View

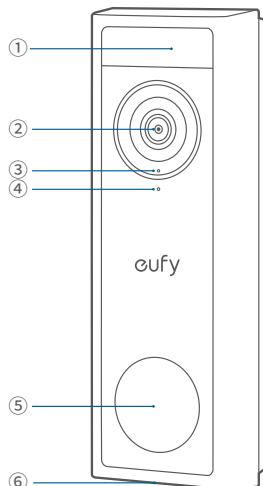

1	Motion Sensor
2	Camera Lens
3	Microphone
4	Ambient Light Sensor
5	LED Ring / Doorbell Button
6	Speaker

Rear View

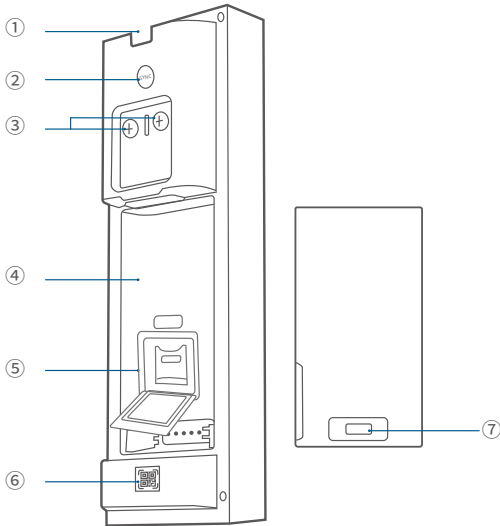

1	Detaching Mechanism
2	SYNC Button <ul style="list-style-type: none"> • Press to turn on the doorbell. • Press and hold for 2 seconds until you hear a beep to set up the doorbell. (Optional) • Press quickly 5 times within 3 seconds to turn off the doorbell.
3	Power Terminals for Existing Doorbell Wires (Optional)
4	Battery Compartment
5	SD Card Slot <ul style="list-style-type: none"> • Lift up the silicone lid to insert the SD Card.
6	QR Code <ul style="list-style-type: none"> • Scan to add the doorbell in the app.
7	USB-C Port <ul style="list-style-type: none"> • Use to charge the battery.

HOW THE SYSTEM WORKS

Works Independently

This video doorbell can work independently once it is connected to your home wireless router. Additionally, you have a variety of options to receive notifications and hear a ring when someone presses your video doorbell.

Use a traditional doorbell chime (if you have one).

Use a eufy Security doorbell chime (sold separately).

Use an Amazon Alexa Echo Show device.

Works with eufy Security HomeBase (Optional)

The video doorbell detects motion at your porch and lets you to answer the door anytime, anywhere. You can store video clips in the built-in storage of your eufy Security HomeBase 2 or S380 HomeBase (sold separately). When someone rings the doorbell, people in the house will be notified.

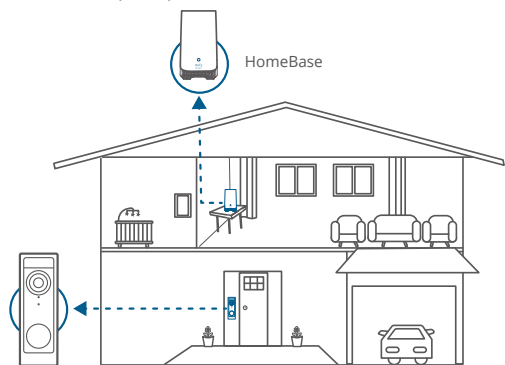

CHARGING THE BATTERY PACK

1. Remove the pre-installed battery pack from the battery compartment.

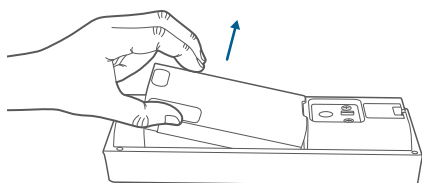

2. Fully charge the rechargeable battery pack before installation.

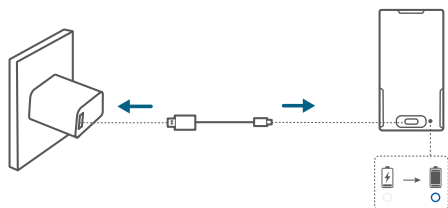

3. Place the battery pack into the battery compartment.

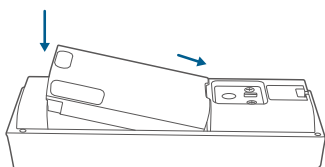

SETTING UP THE SYSTEM

1. Download and install the eufy Security app, then sign in or create an account.



2. Follow the in-app instructions to add the video doorbell.

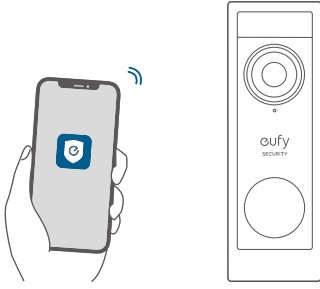

DETERMINING THE POWER OPTION

Option 1: Battery Powered

If you don't have existing doorbell wiring at your front door, use the included battery. You are free to determine the location of the doorbell, and the mounting will be easy and quick.

When the battery is low, you will need to recharge it. Battery life varies with use. If you choose this option, please skip to **DOORBELL MOUNTING (Battery Powered)**.

Option 2: Wire Powered

If you have existing and working doorbell wires at your front door, the video doorbell will be constantly powered by these wires. So there's no need to detach and recharge after installation.

The mounting position is limited. If you choose this option, please skip to **DOORBELL MOUNTING (Wire Powered)**.

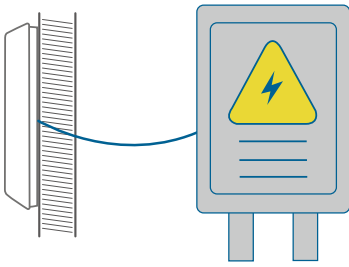

DOORBELL MOUNTING (Battery Powered)

Choose a Location

1. Take the video doorbell to your front door and check the live view in the app. Choose a location where you can see the desired field of view. Consider the following factors:
 - Check if you can reuse the existing holes and anchors in the wall or door frame.
 - If you want to place the doorbell near a side wall, make sure the wall isn't in the field of view. Otherwise, the IR light will be reflected and the night vision will be blurred.
 - If you are drilling the mounting holes for the first time, the recommended height is 48" (1.2m) above the ground.
 - To adjust the angle, use the 15° mounting wedge as a supplementary mounting bracket.

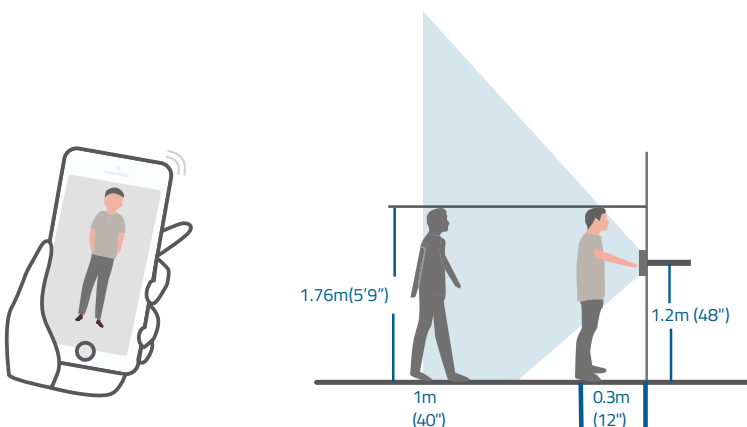

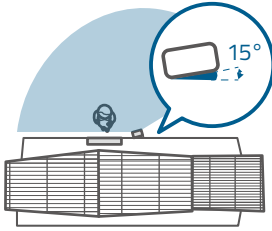
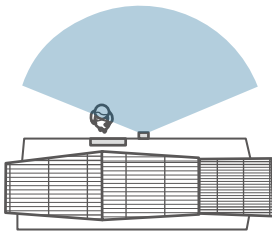

2. Place the screw hole positioning card against the wall to mark the location. If mounting on a hard wall (brick, concrete, or stucco), use a 15/64" (5.95mm) drill bit to drill 2 holes through the screw hole positioning card.

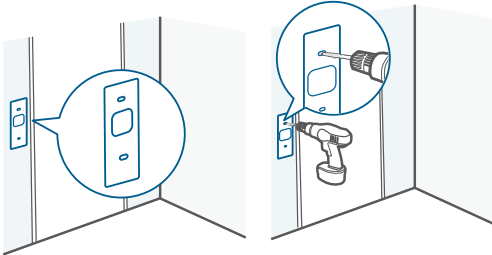

 What you need: Phillips-Head Screwdriver; Power Drill (15/64" Drill Bit)

Mount the Bracket

Use the provided screws to secure the mounting bracket on the wall.

Wooden Wall

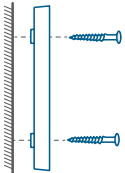

Mounting Bracket

Without 15° Mounting Wedge

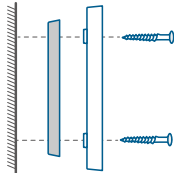

Mounting Wedge

Mounting Bracket

With 15° Mounting Wedge

Hard Wall

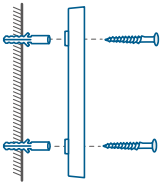

Mounting Bracket

Without 15° Mounting Wedge

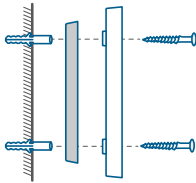

Mounting Wedge

Mounting Bracket

With 15° Mounting Wedge

Install the Doorbell

Align the doorbell with the bottom of the mounting bracket, then press the top of the doorbell into place until it clicks.

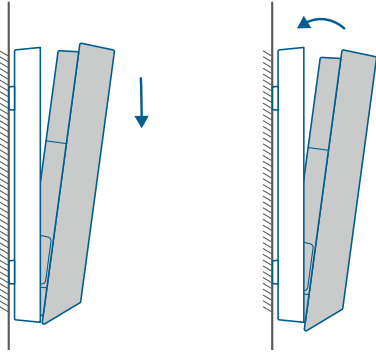

Recharging the Battery

1. Insert the detaching pin into the pin hole on the top of the doorbell, then lift the top for removal.

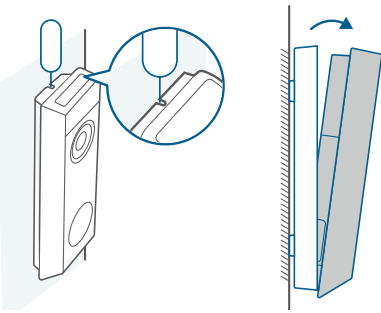

2. Repeat steps in "CHARGING THE BATTERY PACK".

 You can purchase an extra battery pack for quick replacement.

DOORBELL MOUNTING (Wire Powered)

Check the Doorbell Wires

1. Ring the existing doorbell to check if it is working. If it doesn't ring, your doorbell wires may be defective. Power on the doorbell by the built-in battery or consult an electrician to repair the wires.
2. Shut off the power at the circuit breaker. Turn the lights on and off to make sure the electricity in your home is properly shut off.

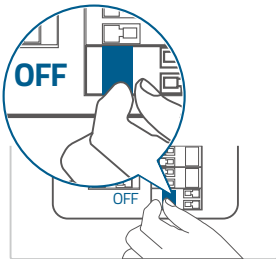

 Always be careful when handling wires. If you're not comfortable installing it yourself, have a qualified electrician to do it.

Detach the Existing Doorbell Button

If you already have existing doorbell wiring:

1. Remove the existing doorbell button with a Phillips-head screwdriver (not provided).
2. Pull the two wires out carefully when removing the existing doorbell. Straighten the wire ends if necessary.

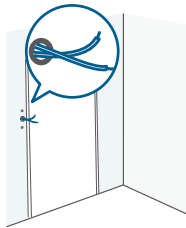
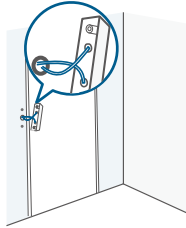
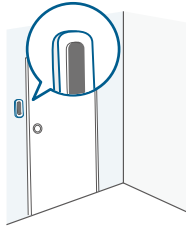

Choose a Location

1. Take the video doorbell to your front door and check the live view in the app. Choose a location where you can see the desired field of view. Consider the following factors:
 - Check if you can reuse the existing holes and anchors in the wall or door frame.
 - If you want to place the doorbell near a side wall, make sure the wall isn't in the field of view. Otherwise, the IR light will be reflected and the night vision will be blurred.
 - If you are drilling the mounting holes for the first time, the recommended height is 48" (1.2m) above the ground.
 - To adjust the angle, use the 15° mounting wedge as a supplementary mounting bracket.

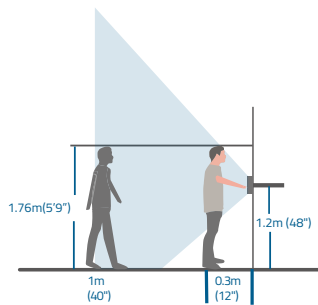
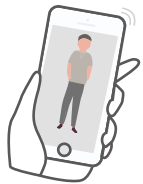

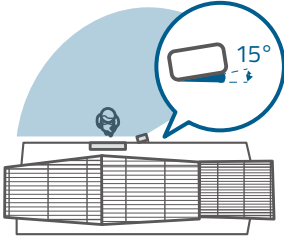
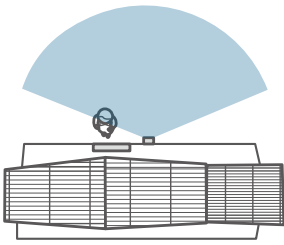

2. Place the screw hole positioning card against the wall to mark the location. If mounting on a hard wall (brick, concrete, or stucco), use a 15/64" (5.95mm) drill bit to drill 2 holes through the screw hole positioning card.

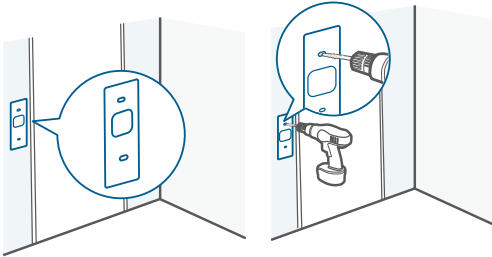

 What you need: Phillips-Head Screwdriver; Power Drill (15/64" Drill Bit)

Mount the Bracket

Use the provided screws to secure the mounting bracket on the wall.

Wooden Wall

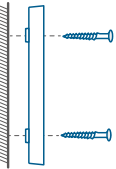

Mounting Bracket

Without 15° Mounting Wedge

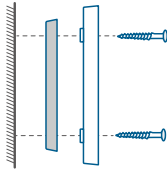

Mounting Wedge Mounting Bracket

With 15° Mounting Wedge

Hard Wall

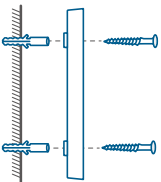

Mounting Bracket

Without 15° Mounting Wedge

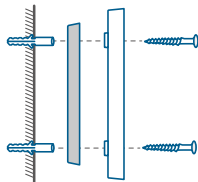

Mounting Wedge Mounting Bracket

With 15° Mounting Wedge

Connect the Wires to the Doorbell

Connect the wires to the terminals on the back of the doorbell, then tighten the terminal screws. Wire can be connected to any terminal.

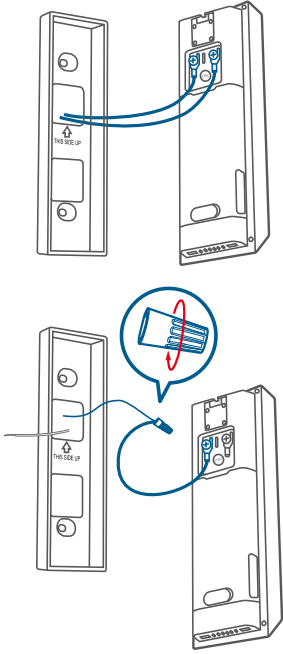

- 💡 1. To prevent short-circuiting, make sure the wires are not touching each other after connecting them to the terminals.
- 2. If the wires are too short, use the extension wires and wire nuts to make them longer. Use electrical wiring tape instead if there is no more space on the wall for wire nuts.

Install the Doorbell

Align the doorbell with the bottom of the mounting bracket, then press the top of the doorbell into place until it clicks.

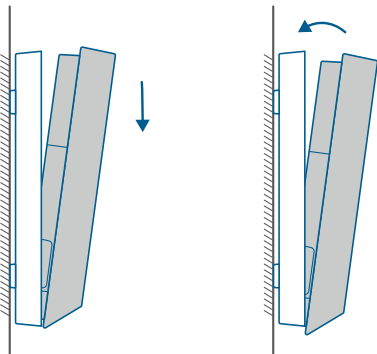

Restore Power

Switch the main circuit breaker back to **ON**. You're all set!

