

WonderLink™ - Compatible eufy Devices

What's in the Box

At a Glance

Testing the Lights

Setting up the System

Installing your Outdoor Lights

Specifications

Troubleshooting

Customer Service

Important Safety Instructions

WonderLink™ - Compatible eufy Devices

Check this list to find a eufy device that works with Wonderlink™.

Wall Light Cam	Wired Wall Light Cam S100 Solar Wall Light Cam S120
Video Smart Lock	Video Smart Lock S330 Video Smart Lock E330
eufyCam	eufyCam S330 (eufyCam 3) eufyCam S300 (eufyCam 3C) eufyCam S221 (eufyCam 2 Pro) eufyCam S220 (eufyCam 2C Pro) eufyCam 2 eufyCam S210 (eufyCam 2C) eufyCam E eufyCam
Video Doorbell	Video Doorbell E340 (Battery Powered) Video Doorbell S330 Video Doorbell S220 Video Doorbell S210 Video Doorbell C210 Video Doorbell C220 Video Doorbell (Wired) S330
Indoor Cam	Indoor Cam S350 Solo IndoorCam C24 Indoor Cam E220 Solo IndoorCam C22 Solo IndoorCam P22 Indoor Cam Mini
SoloCam	SoloCam S340 SoloCam S220 SoloCam C110 SoloCam C120 SoloCam E210 SoloCam E220 SoloCam S230 (S40)
Outdoor Cam	Outdoor Cam E210 Outdoor Cam E220
Floodlight Cam	Floodlight Camera E340 Floodlight Cam E220 Floodlight Cam E221 Floodlight Cam S330
4G Cam	eufy 4G LTE Cam S330
Garage-Control Cam	Garage-Control Cam E110 Garage-Control Cam E120

What's in the Box



Pathway Lights x4

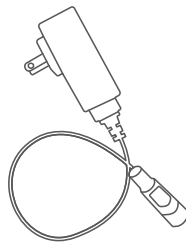

Power Adapter

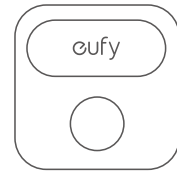

Control Unit

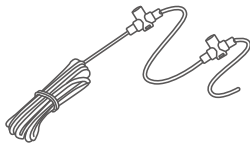

Wire with T Connectors



Ground Stakes x4



Quick Start Guide

At a Glance

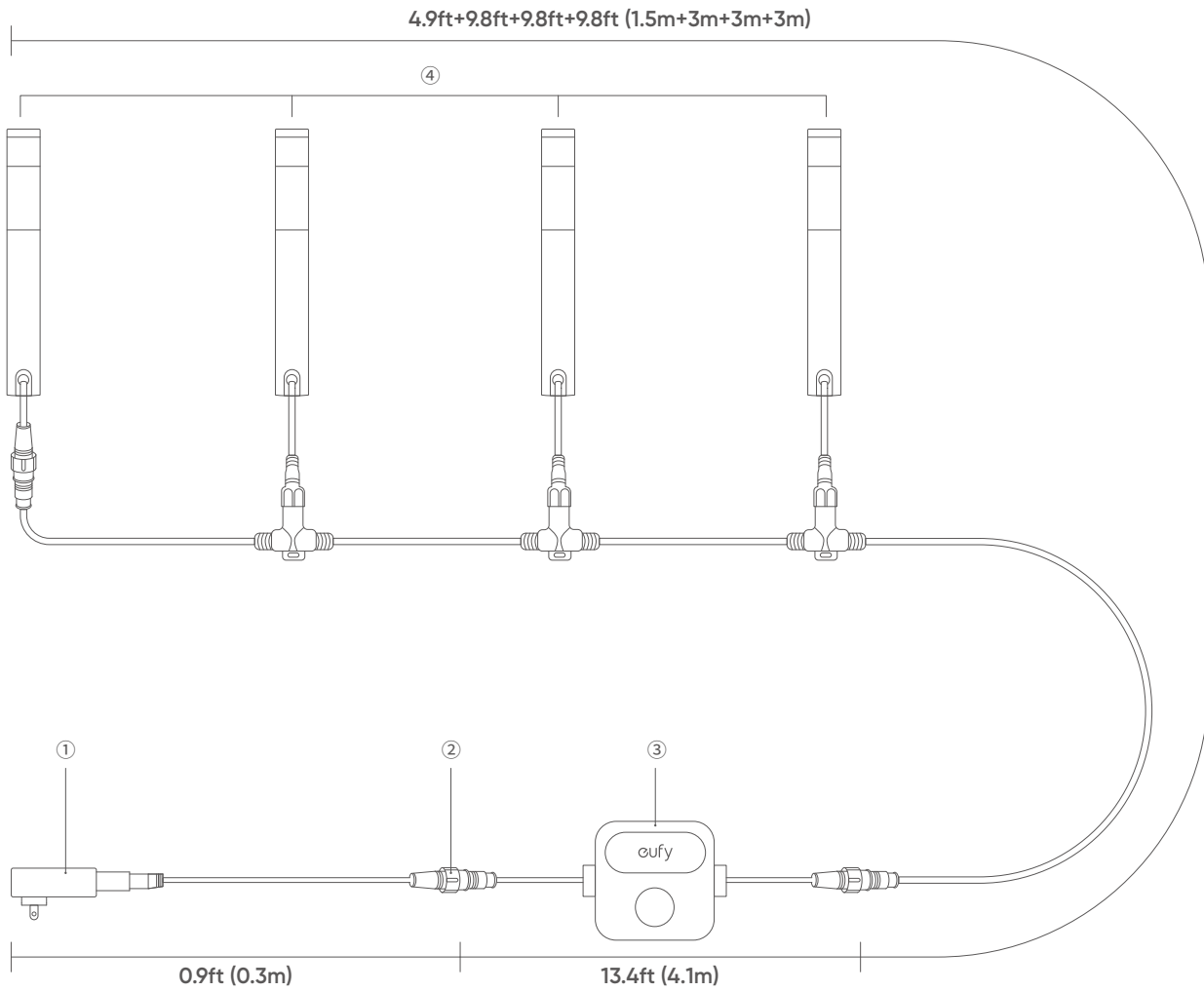

- ① Power Adapter
- ② Waterproof Cap
- ③ Control Unit (Power Button)
 - Press to turn on/off the lights.
 - Press and hold for 2 seconds to enable the pairing mode.
- ④ Pathway Lights

Testing the Lights

-  Connect the lights with the adapter unplugged. Avoid connecting while the adapter is plugged. If you connect the lights while adapter is plugged, the lights may not light up.
- A maximum of 4 lights can be connected to the power adapter.

1. Connect all lights together, then connect them to the control unit and power adapter.

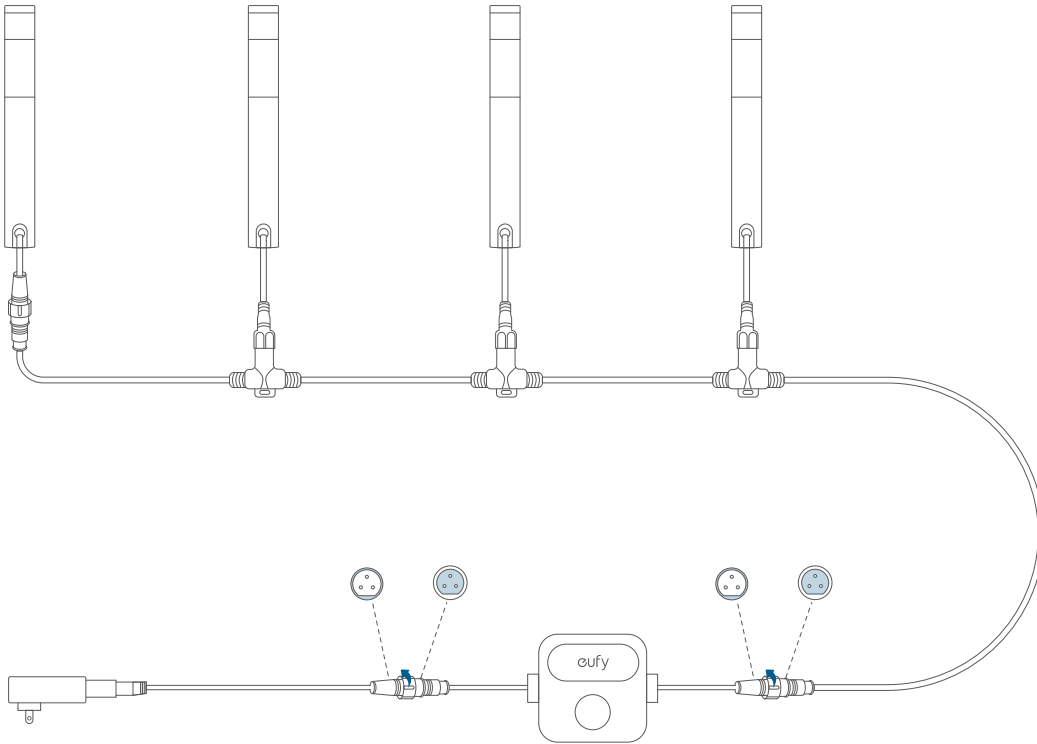

- Make sure the pin connections on the interface are correct.
- Avoid using brute force to prevent damage to the product.

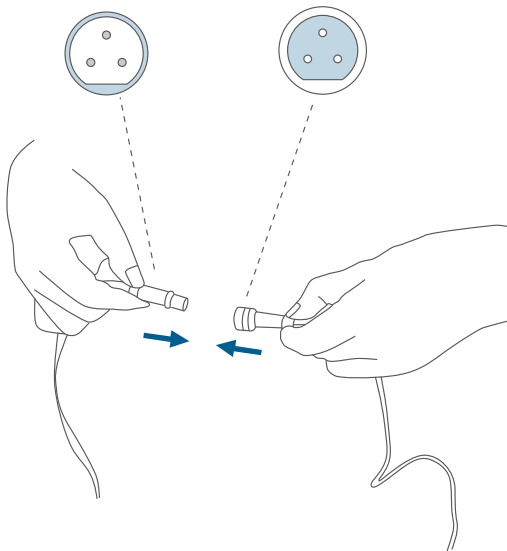

2. Secure the waterproof caps for each connection.

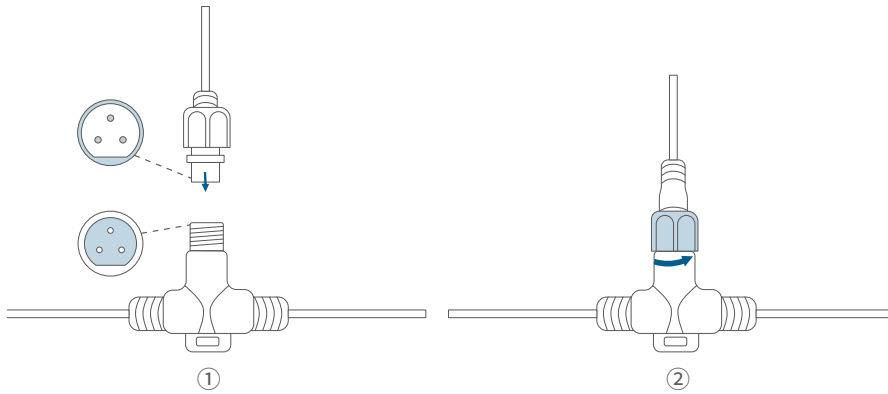

3. Plug in the power supply to verify that each light is working properly.

- The power adapter is rated as IP44 waterproof. It is recommended to plug the adapter into an outdoor socket with a waterproof cover.
- If some of the lights do not light up, unplug and reconnect the power adapter. Make sure the lights are working properly before proceeding to the next step.
- See "**Troubleshooting**" for other lighting problems that may occur.

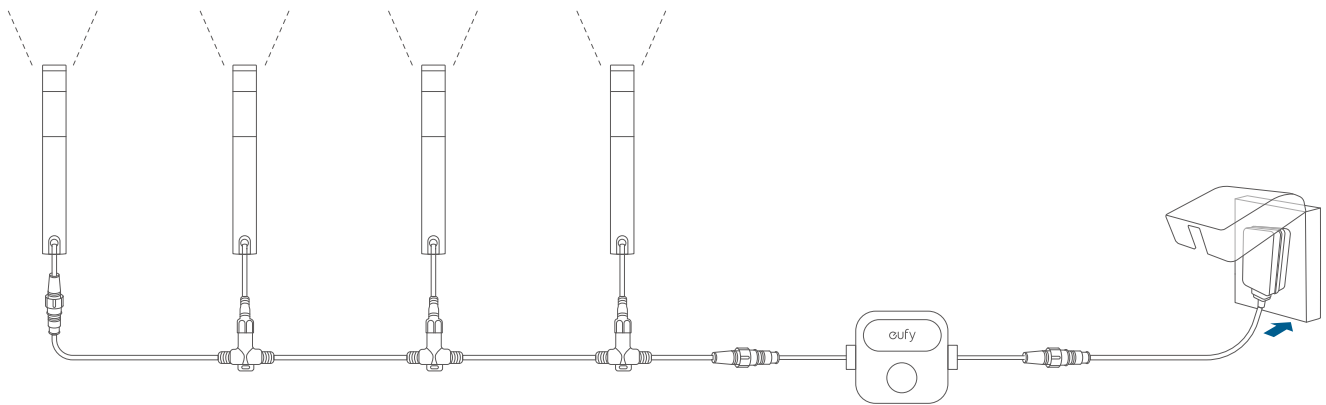

Setting up the System

1. Download and install the eufy Life app, then sign in or create an account.

- Make sure that the eufy Life app is version 2.11.0 or later to support this light strip.



2. Follow the in-app instructions to add this device and complete the setup.

Installing your Outdoor Lights

Install the lights on the ground. The installation will take approximately 15 to 20 minutes.

1. Screw the ground stake into the bottom of the pathway light.



2. Insert the ground stake into the ground, and ensure that it is securely installed.

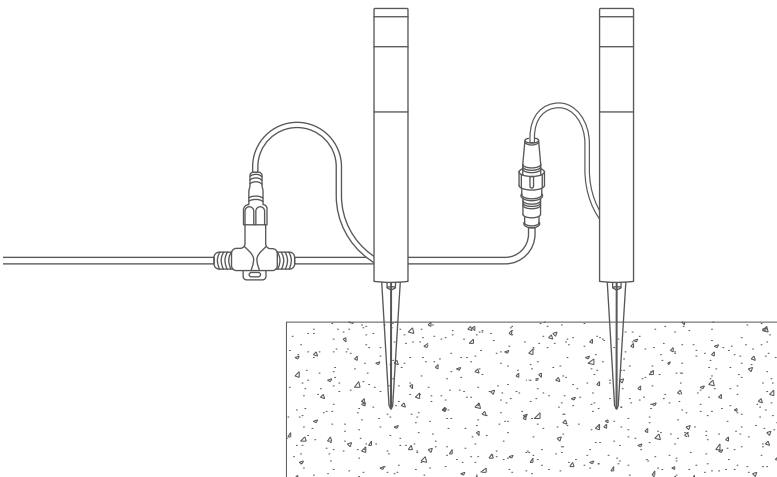

Specifications

Input (Power Adapter)	24W 120V AC ~, 50/60Hz (US) 100-240V AC ~, 50/60Hz (EU, UK, Australia)
Input (Lights)	27V=0.88A
Length	50ft (15m) (4 packs)
Length (Other Components)	Control Unit Cable: 13.4ft (4.1m) Power Adapter Cable: 0.9ft (0.3m) Wire with T connectors: 4.9ft+9.8ft+9.8ft+9.8ft (1.5m+3m+3m+3m)
IP Ratings	Light: IP65 Control Unit: IP65 Power Adapter: IP44
Light Displaying Technology	RGBWWIC
Working Temperature	Product Set: -20°C to 40°C (-4 °F to 104 °F) Lights: -20°C to 60°C (-4 °F to 140 °F)

Troubleshooting

1. Cannot connect to Wi-Fi.

- The 5GHz network is not supported. Please set the router to 2.4GHz and then reset it.
- Do not skip the Wi-Fi connection steps in the app.
- Make sure you have entered the correct Wi-Fi name and password.
- Connect the hotspot of your phone to the product.

2. Some lights do not glow.

- Unplug the power adapter, disconnect and reconnect all components, and plug the power adapter in again.
- If the problem persists, contact eufy support team for a product replacement.

Customer Service

- Lifetime Technical Support
- 18-month Limited Warranty

Important Safety Instructions

- This product is IP65 rated. It can be used outdoors, but immersion in water is not recommended.
- This power adapter is IP44 rated. It can be used outdoors, but immersion in water is not recommended. An outdoor socket with a waterproof cover is preferred.
- Tighten up the waterproof cap before using the light.
- The lamp bead and other internal parts of the product cannot be replaced. If damaged, please contact eufy@support.com for a product replacement.
- Do not allow children to assemble or install this product.
- Be careful with the sharp ground stakes of the product.
- Avoid installing this product in a closed environment or near large heat sources.
- The recommended temperature range for devices and accessories is -20°C to 40°C (-4°F to

104°F) .

- Unless specifically indicated that it is safe to do so in the user guide or instruction manual, do not use this device in an environment that exceeds the recommended low or high temperature.
- Unless specifically indicated that it is safe to do so in the user guide or instruction manual, avoid exposing your device to direct sunshine or excessively wet environments.
- For pluggable equipment, the socket outlet should be easily accessible.
- Use only the adapter provided by the manufacturer. Using unauthorized adapters may cause danger and violate the authorized use of the device or the warranty article. External dimmers cannot be used with this product.