

WonderLink™ - Compatible eufy Devices

What's in the Box

At a Glance

Testing the Lights

Setting up the System

Installing your Outdoor Light

Specifications

Troubleshooting

Customer Service

Important Safety Instructions

WonderLink™ - Compatible eufy Devices

Check this list to find a eufy device that works with Wonderlink™.

Wall Light Cam	Wired Wall Light Cam S100 Solar Wall Light Cam S120
Video Smart Lock	Video Smart Lock S330 Video Smart Lock E330
eufyCam	eufyCam S330 (eufyCam 3) eufyCam S300 (eufyCam 3C) eufyCam S221 (eufyCam 2 Pro) eufyCam S220 (eufyCam 2C Pro) eufyCam 2 eufyCam S210 (eufyCam 2C) eufyCam E eufyCam
Video Doorbell	Video Doorbell E340 (Battery Powered) Video Doorbell S330 Video Doorbell S220 Video Doorbell S210 Video Doorbell C210 Video Doorbell C220 Video Doorbell (Wired) S330
Indoor Cam	Indoor Cam S350 Solo IndoorCam C24 Indoor Cam E220 Solo IndoorCam C22 Solo IndoorCam P22 Indoor Cam Mini
SoloCam	SoloCam S340 SoloCam S220 SoloCam C110 SoloCam C120 SoloCam E210 SoloCam E220 SoloCam S230 (S40)
Outdoor Cam	Outdoor Cam E210 Outdoor Cam E220
Floodlight Cam	Floodlight Camera E340 Floodlight Cam E220 Floodlight Cam E221 Floodlight Cam S330
4G Cam	eufy 4G LTE Cam S330
Garage-Control Cam	Garage-Control Cam E110 Garage-Control Cam E120

What's in the Box

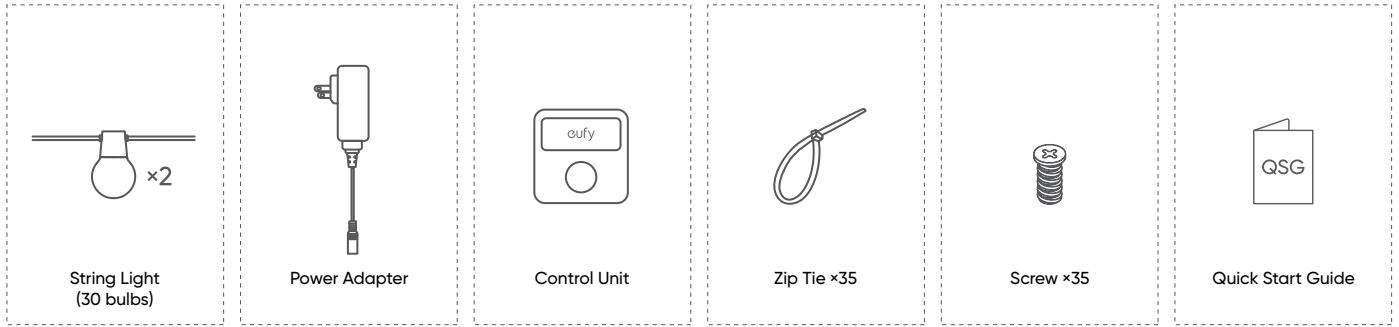

At a Glance

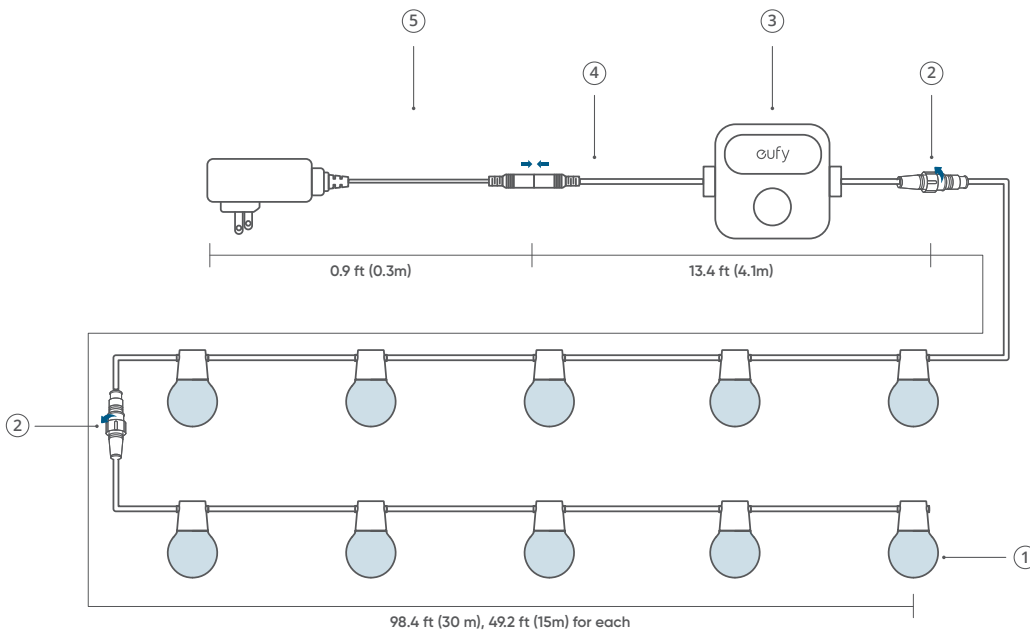

- ① Bulbs
- ② Waterproof Connectors
- ③ Control Unit (Power Button)
 - Press to turn on the light or switch between different light effects.
 - Press and hold for 2 seconds to turn off the light.
- ④ Power Connector
- ⑤ Power Adapter

Testing the Lights

-  Connect the light strings with the adapter unplugged. Avoid connecting while the adapter is plugged. If you connect the light strings while adapter is plugged, the strings may not light up.
- A maximum of 2 light strings (15 bulbs for each string) can be connected to the power adapter.

1. Connect all light strings together, then connect them to the control box and power adapter. Secure the waterproof caps for each connection and the end of the last light string.

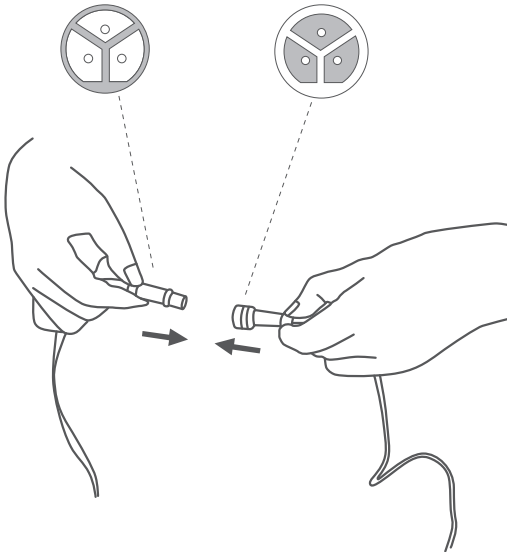

2. Plug in the power supply to verify that each light string is working properly.

- If some of the light strings do not light up, unplug and replug the power adapter. Make sure the light strings are working properly before proceeding to the next step.
- See "Troubleshooting" for other lighting problems that may occur.

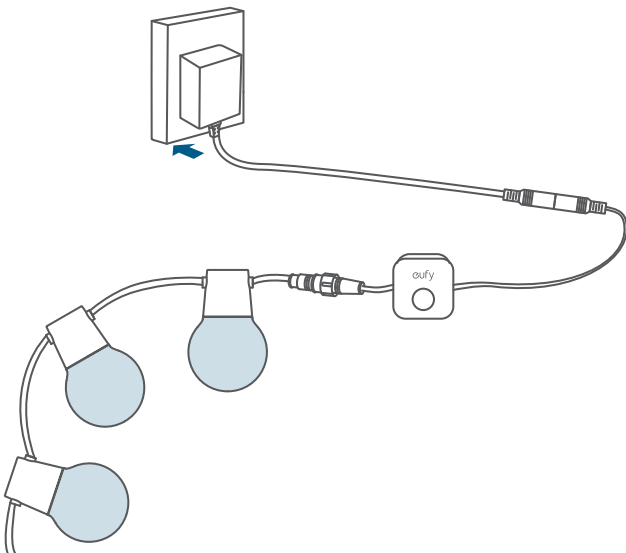

Setting up the System

1. Download and install the eufy Life app, then sign in or create an account.
 - Make sure that the eufy Life app is version 2.11.0 or later to support this light strip.



2. Follow the in-app instructions to add this device and complete the setup.

Installing your Outdoor Light

The installation will take approximately 10 minutes. There are 3 ways to install your string lights. If you are installing the lights on the left side of the power outlet, option 2 is recommended.

Option 1 Install with Hooks

Install a guide wire (recommended diameter: 3mm to 5mm) at your desired location, and attach the bulb to the guide wire using the hook.

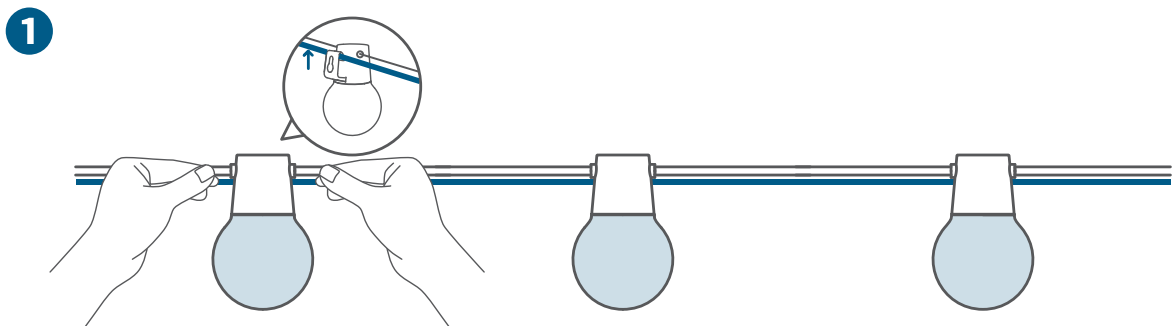

Option 2 Install with Zip Ties

Install a guide wire (recommended diameter: 3mm to 5mm) at your desired location, and tie the string light cable to the guide wire with zip ties.

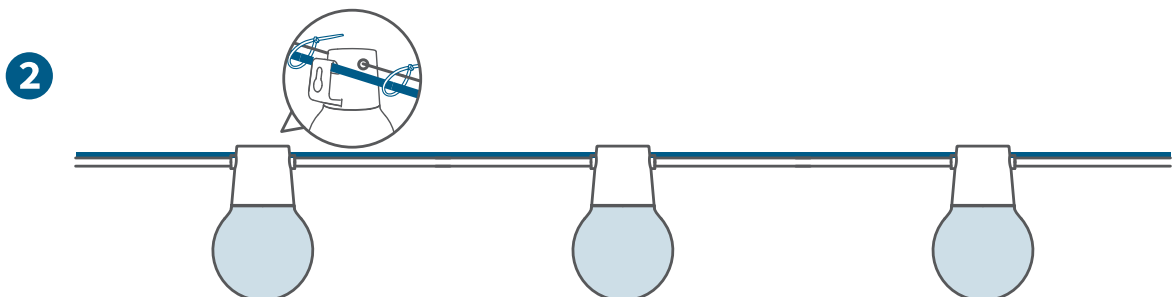

Option 3 Install with Screws

Install a guide wire (recommended diameter: 3mm to 5mm) at your desired location, and tie the string light cable to the guide wire with zip ties.

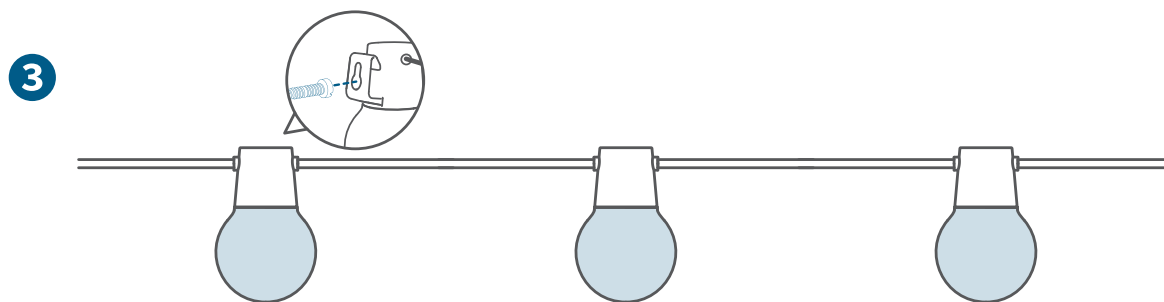

Specifications

Input (Power Adapter)	24W 120V AC ~, 50/60Hz (US) 100-240V AC ~, 50/60Hz (EU, UK, Australia)
Input (Lights)	24V=1A
Component Length	Light Strings: 98.4 ft (30 m), 49.2 ft (15m) for each Control Unit Cable: 13.4 ft (4.1m) Power Adapter: 0.9 ft (0.3m)
Light Displaying Technology	RGBWWIC
Working Temperature	Whole Device: -20°C to 40°C (-4°F to 104°F) Light Strings: -20°C to 60°C (-4°F to 140°F)
IP Ratings	Light Strings: IP65 Control Unit: IP65 Power Adapter: IP44

Troubleshooting

1. Cannot connect to Wi-Fi.

- The 5GHz network is not supported. Please set the router to 2.4GHz and then reset it.
- Do not skip the Wi-Fi connection steps in the app.
- Make sure you have entered the correct Wi-Fi name and password.
- Connect the hotspot of your phone to the product.

2. Light doesn't glow at all / Some lights do not glow.

- If only the first string glows while the power adapter is plugged in, unplug the power adapter and plug it in again.
- If some lights don't glow, disconnect all components and reconnect all components and plug the power adapter in again, or press the control unit to reset the light string.
- To reset the lights, unplug the power supply, reconnect it and wait for 1 minute. Press and hold the control unit for 5 seconds, and the white lights start to blink on and off for 5 repeated runs, indicating the device is reset successfully.

- If any of the selected light effects are not fully displayed, contact eufy support team for further analysis or product replacement.

Customer Service

- Lifetime Technical Support
- 18-month Limited Warranty

Important Safety Instructions

- The power adapter is IP44 rated. An outdoor socket with a waterproof cover is preferred.
- Ensure that all waterproof connectors are tightly secured when installing the string light.
- The lamp bead and other internal parts of the product cannot be replaced. If damaged, please contact eufy@support.com for a product replacement.
- Do not allow children to assemble or install this product.
- Avoid installing this product in a closed environment or near large heat sources.
- The recommended temperature range for devices and accessories is -20°C to 40°C (-4°F to 104°F).
- Unless specifically indicated that it is safe to do so in the user guide or instruction manual, do not use this device in an environment that exceeds the recommended low or high temperature.
- Unless specifically indicated that it is safe to do so in the user guide or instruction manual, avoid exposing your device to direct sunshine or excessively wet environments.
- For pluggable equipment, the socket outlet should be easily accessible.
- Use only the adapter provided by the manufacturer. Using unauthorized adapters may cause danger and violate the authorized use of the device or the warranty article. External dimmers cannot be used with this product.
- Ensure the cables are installed without overstretching.