

Aqara

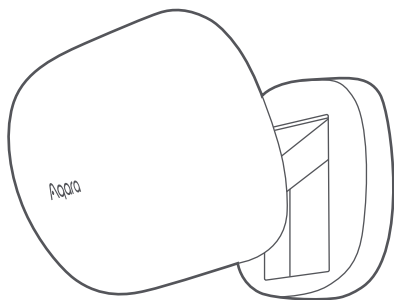

Presence Sensor FP1E User Manual **EN**

Product Introduction

Presence Sensor FP1E is a sensor designed for accurately detecting the presence of human objects in space. Combining millimeter-wave radar technology with advanced AI algorithms, it features functions such as spatial background learning, interference source identification, and sensitivity adaptation.

* This device requires use with the Aqara Home app and Aqara Hub

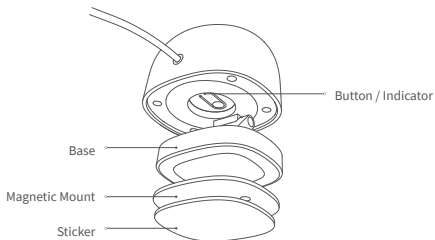

Quick Setup

1. Before activating the device, please make sure you have the Aqara Home app downloaded and Aqara hub installed.



Aqara Home App

2. Power the Presence Sensor FP1E, press and hold the reset button for 5 seconds until the LED indicator starts blinking, and release it. The device will enter pairing mode.

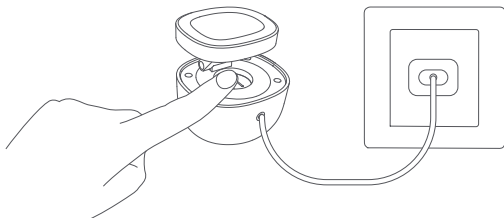

3. Open the Aqara Home app, tap "Home" and then tap "+" in the top-right corner to enter the "Add Device (Accessory)" page. Select "Presence Sensor FP1E" or scan the installation code on the device and add it according to instructions.

* If the connection fails, please move the device closer to the Hub and try again.

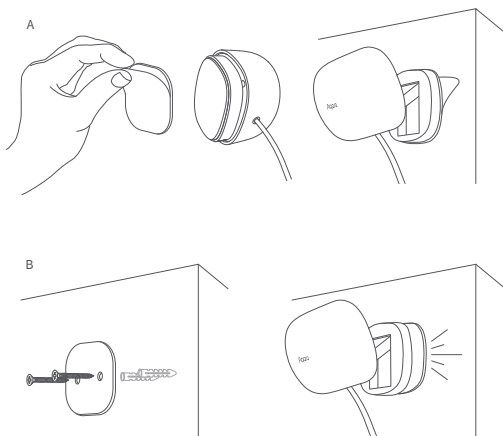

Radar Detection Range

Wall Mounting: When Wall Mounting, the device has a maximum detection distance of 6m, a field of view (FOV) angle of 120°, and a close-range FOV angle of up to 180°. It can be used for space detection of up to 35m².

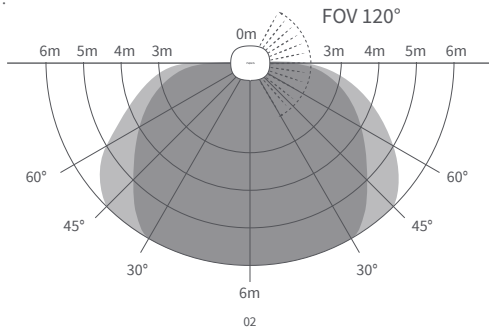

Ceiling-mounting: When the device is installed horizontally downward on a ceiling with a height of 2.8m, the detection area is approximately a circle with a radius of 4 meters below the device, and the maximum detection space area is approximately up to 50 m².

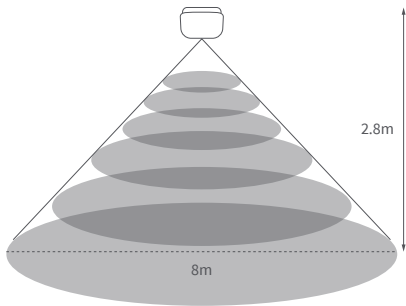

* The above detection range is theoretical under ideal laboratory conditions. The detection range may vary slightly depending on the actual space environment, installation height and angle.

Detection Range Setting

The device has a maximum detection range of 6m by default, and supports users to customize the maximum detection range within 6 meters at intervals of 30 cm to exclude areas that do not need to be detected.

When setting the detection range, please ensure that there is only one person in the space to ensure the accuracy of the reference distance. When setting, if there is someone in the space, the current position will be displayed in real time on the interface as a reference. If there are multiple people, the current position will be estimated based on the nearest target.

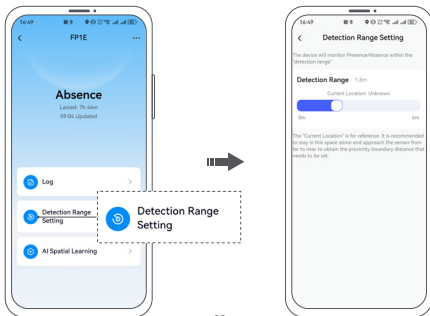

Note: The distance displayed in the "Current Location" is the straight-line distance from the device to the point where the energy of the human body is the largest. It is not the actual horizontal distance between the human body and the device that is strictly and accurately calculated. There may be errors with the distance perceived by the user. It is only used as a reference when setting the Detection range boundary. When the Detection range exceeds 6 meters, the "Current Location" will display "Unknown".

To ensure the accuracy of the detection range setting, it is recommended that the user slowly approach the device from far to near when setting it, walk to the boundary of the range that needs to be detection, observe the changes in the current position, and when the current distance is stable, set the current position distance to the required detection range. After setting, compare the presence status on the homepage to make fine adjustments.

AI Spatial Learning

AI spatial learning can intelligently learn the environmental background, eliminate the false alarms of large areas of glass, metal, mirrors, etc. on the detection results, intelligently adapt to environmental false alarms sources, and improve the accuracy of detection results.

It is recommended that users actively conduct AI spatial learning after the device is installed. AI spatial learning requires that the space be unmanned and takes about 30 seconds. Please wait patiently.

During use, the device will continue to learn the spatial background through AI to adapt to the real-time changing spatial environment, making the device more accurate with use.

If, under special circumstances, the user finds that the device mistakenly reports a false presence status when the space should be absence, an AI spatial learning can be performed immediately to quickly restore the space to an empty state.

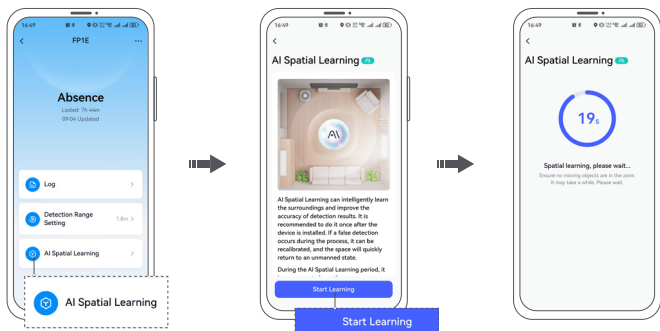

Automation Configuration

Users can simply go to the App "Automation" interface and click "+" in the upper-right corner to add Automation related to the device.



Automation conditions	Presence	The presence of a person is detected in the space
	Absence	Space detects no one is present
	Presence for (a period of time)	There are people present and the time exceeds a certain limit
	Absence for (a period of time)	No one and the time exceeds a certain limit
	Still	When there are people in the space and the targets are in a relatively still state (such as sitting or lying still, with small movement and displacement), it can be used as a sedentary reminder.
	Still for (a period of time)	There are people in the space, and the targets are in a relatively still state for a certain period of time.
	Moving	There are people in the space, and the targets are in a relatively active state (such as walking or exercising), which can be used to trigger active scenes such as turning on fresh air, lowering the Air conditioning temperature, and other related Automation)
	Moving for (a period of time)	Moving state and exceeding a certain time

Automation Actions	AI Spatial Learning	It can intelligently learn environmental background, intelligently adapt to environmental false alarms sources, and improve the accuracy of detection results. It is recommended that users actively conduct an AI space background learning after the device is installed. If, in special circumstances, users find that the device misidentifies a presence status, they can also conduct an AI space background learning immediately, to quickly restore the space to an empty state.
	Reboot device	The device will restart

Recommended Automation Configuration

By referring to the following automation recommendations, you can start using the device immediately within one minute, complete smart home linkage, and experience the charm of Presence Sensor FP1E.

1. When "Presence", Then "turn on the light";
2. When "Absence for a certain period of time", Then "turn off the lights or the Air conditioning";
3. When "Moving for a certain period of time", Then "adjust the Air conditioning to 25 degrees";
4. When "Still for a certain period of time", Then "push a message (sedentary reminder)".

More Useful Tips

1. It is recommended to install the device facing the front of the human body to make it easier to detect the micro-movement of human breathing.
2. The detection range of the device can reach 6 meters. It is recommended to configure the detection range according to actual needs, exclude unnecessary detection areas, and improve detection accuracy.
3. The time it takes for the device to detect when someone is there and when no one is, is very fast. To improve the user experience and avoid frequent switching of lights, it is recommended to select "no one and for more than a certain period of time" instead of "no one" in the Automation conditions.
4. If the device mistakenly identifies an unmanned state as a human being, you can use the AI spatial background learning function to quickly return to the unmanned state.
5. The device has AI false alarms source identification and continuous spatial self-learning capabilities, and can become more accurate with use. However, in order to maximize detection accuracy, it is still recommended to avoid installing the device next to Air conditioning outlets, air purifiers, and fans.

Button Configuration

Button Operation	Device action
Single Press	Effective Range Test
Long Press for 5s	Reset/Connect to Network

Indicator Configuration

Indicator status	Device status
Blue flashes 2 times	Appears when the power is turned on again, indicating that the power supply is normal
Blue flashes 3 times	Start Zigbee search
Flashes blue once every 2 seconds	The device is in the Zigbee network search state
Blue flashes 2 times	1. Zigbee connection and networking is successful 2. Zigbee device search operation is successful 3. Factory reset successful
Blue for 1 second	Zigbee connection failure & networking failure

Specifications

Presence Sensor FP1E

Model: PS-S03D / PS-S03E

Ports: USB-A

Input Power: 5 V \pm 1 A

Made in China

Wireless Protocols: Zigbee

Radar Maximum Output Power \leq 20 dBm (Only applicable to the EU region)

What is in the Box: Presence Sensor FP1E \times 1, User Manual \times 1, Sticker \times 1, Magnetic Mount \times 1.

Radar Operation Frequency: 60-61 GHz

Zigbee Operation Frequency: 2405-2480 MHz

Zigbee Maximum Output Power \leq 13 dBm

Dimensions: 57 \times 50 \times 37 mm (2.24 \times 1.97 \times 1.46 in.)

Operating Temperature: -10 $^{\circ}$ C \sim 40 $^{\circ}$ C (14 $^{\circ}$ F \sim 104 $^{\circ}$ F)

Operating Humidity: 0 \sim 95% RH, no condensation

Warnings

1. This product is NOT a toy. Please keep children away from this product.
2. This product is designed for indoor use only. Do NOT use it in humid environments or outdoors.
3. Beware of moisture, do NOT spill water or other liquids onto the product.
4. Do NOT place this product near a heat source. Do NOT place it in an enclosure unless there is normal ventilation.
5. Do NOT attempt to repair this product by yourself. All repairs should be performed by an authorized professional.
6. This product is only suitable for improving the entertainment, convenience of your home life and reminding you about the device status. If a user violates the product use instructions, the manufacturer will NOT be liable for any risks and property losses.



EU Declaration of Conformity

Hereby, [Lumi United Technology Co., Ltd] declares that the radio equipment type [Presence Sensor FP1E, PS-S03D / PS-S03E] are in compliance with Directive 2014/53/EU. The full text of the EU declaration of conformity is available at the following internet address: <https://www.aqara.com/DoC/>



WEEE Disposal and Recycling Information

All products bearing this symbol are waste electrical and electronic equipment (WEEE as in directive 2012/19/EU) which should not be mixed with unsorted household waste. Instead, you should protect human health and the environment by handing over your waste equipment to a designated collection point for the recycling of waste electrical and electronic equipment, appointed by the government or local authorities. Correct disposal and recycling will help prevent potential negative consequences to the environment and human health.

Please contact the installer or local authorities for more information about the location as well as terms and conditions of such collection points.

Under normal use of condition, this equipment should be kept a separation distance of at least 20cm between the antenna and the body of the user.

FCC ID: 2AKIT-PSS03

Federal Communications Commission (FCC) compliance statement:

1. This device complies with part 15 of the FCC Rules. Operation is subject to the following two conditions:
 - (1) This device may not cause harmful interference, and
 - (2) This device must accept any interference received, including interference that may cause undesired operation.
2. Changes or modifications not expressly approved by the party responsible for compliance could void the user's authority to operate the equipment.

Note: This equipment has been tested and found to comply with the limits for a Class B digital device,

pursuant to part 15 of the FCC Rules. These limits are designed to provide reasonable protection against harmful interference in a residential installation.

This equipment generates, uses and can radiate radio frequency energy and, if not installed and used in accordance with the instructions, may cause harmful interference to radio communications. However, there is no guarantee that interference will not occur in a particular installation. If this equipment does cause harmful interference to radio or television reception, which can be determined by turning the equipment off and on, the user is encouraged to try to correct the interference by one or more of the following measures:

-Reorient or relocate the receiving antenna.

-Increase the separation between the equipment and receiver.

-Connect the equipment into an outlet on a circuit different from that to which the receiver is connected.

-Consult the dealer or an experienced radio/TV technician for help. RF Exposure statement:

This equipment complies with FCC radiation exposure limits set forth for an uncontrolled environment.

This equipment should be installed and operated with a minimum distance of 20 cm between the radiator and your body. This transmitter must not be co-located or operating in conjunction with any other antenna or transmitter.

IC: 22635-PSS03

IC NOTICE TO CANADIAN USERS

This device contains license-exempt transmitter(s)/receiver(s) that comply with Innovation, Science and Economic Development Canada's license-exempt RSS(s). Operation is subject to the following two conditions:

(1) This device may not cause interference.

(2) This device must accept any interference, including interference that may cause undesired operation of the device.

This Class B digital apparatus complies with Canadian ICES - 003.

This device complies with RSS - 247 of Industry Canada. Operation is subject to the condition that this device does not cause harmful interference.

This equipment complies with IC radiation exposure limits set forth for an uncontrolled environment. This equipment should be installed and operated with minimum distance of 20 cm between the radiator and your body. This transmitter must not be co-located or operating in conjunction with any other antenna or transmitter.

Manufacturer: Lumi United Technology Co., Ltd.

Address: Room 801-804, Building 1, Chongwen Park, Nanshan iPark, No. 3370, Liuxian Avenue, Fuguang Community, Taoyuan Residential District, Nanshan District, Shenzhen, China.

Online Customer Service: www.aqara.com/support

Email: support@aqara.com